

DENON

AV SURROUND RECEIVER

AVR-588

Owner's Manual

Manuel de l'Utilisateur

SAFETY PRECAUTIONS



CAUTION
RISK OF ELECTRIC SHOCK
DO NOT OPEN



CAUTION:
TO REDUCE THE RISK OF ELECTRIC SHOCK, DO NOT REMOVE COVER (OR BACK). NO USER-SERVICEABLE PARTS INSIDE. REFER SERVICING TO QUALIFIED SERVICE PERSONNEL.

The lightning flash with arrowhead symbol, within an equilateral triangle, is intended to alert the user to the presence of uninsulated "dangerous voltage" within the product's enclosure that may be of sufficient magnitude to constitute a risk of electric shock to persons.

The exclamation point within an equilateral triangle is intended to alert the user to the presence of important operating and maintenance (servicing) instructions in the literature accompanying the appliance.

WARNING:
TO REDUCE THE RISK OF FIRE OR ELECTRIC SHOCK, DO NOT EXPOSE THIS APPLIANCE TO RAIN OR MOISTURE.

SAFETY INSTRUCTIONS

1. Read Instructions – All the safety and operating instructions should be read before the product is operated.
2. Retain Instructions – The safety and operating instructions should be retained for future reference.
3. Heed Warnings – All warnings on the product and in the operating instructions should be adhered to.
4. Follow Instructions – All operating and use instructions should be followed.
5. Cleaning – Unplug this product from the wall outlet before cleaning. Do not use liquid cleaners or aerosol cleaners.
6. Attachments – Do not use attachments not recommended by the product manufacturer as they may cause hazards.
7. Water and Moisture – Do not use this product near water – for example, near a bath tub, wash bowl, kitchen sink, or laundry tub; in a wet basement; or near a swimming pool; and the like.
8. Accessories – Do not place this product on an unstable cart, stand, tripod, bracket, or table. The product may fall, causing serious injury to a child or adult, and serious damage to the product. Use only with a cart, stand, tripod, bracket, or table recommended by the manufacturer, or sold with the product. Any mounting of the product should follow the manufacturer's instructions, and should use a mounting accessory recommended by the manufacturer.
9. A product and cart combination should be moved with care. Quick stops, excessive force, and uneven surfaces may cause the product and cart combination to overturn.
10. Ventilation – Slots and openings in the cabinet are provided for ventilation and to ensure reliable operation of the product and to protect it from overheating, and these openings must not be blocked or covered. The openings should never be blocked by placing the product on a bed, sofa, rug, or other similar surface. This product should not be placed in a built-in installation such as a bookcase or rack unless proper ventilation is provided or the manufacturer's instructions have been adhered to.
11. Power Sources – This product should be operated only from the type of power source indicated on the marking label. If you are not sure of the type of power supply to your home, consult your product dealer or local power company. For products intended to operate from battery power, or other sources, refer to the operating instructions.
12. Grounding or Polarization – This product may be equipped with a polarized alternating-current line plug (a plug having one blade wider than the other). This plug will fit into the power outlet only one way. This is a safety feature. If you are unable to insert the plug fully into the outlet, try reversing the plug. If the plug should still fail to fit, contact your electrician to replace your obsolete outlet. Do not defeat the safety purpose of the polarized plug.
13. Power-Cord Protection – Power-supply cords should be routed so that they are not likely to be walked on or pinched by items placed upon or against them, paying particular attention to cords at plugs, convenience receptacles, and the point where they exit from the product.
15. Outdoor Antenna Grounding – If an outside antenna or cable system is connected to the product, be sure the antenna or cable system is grounded so as to provide some protection against voltage surges and built-up static charges. Article 810 of the National Electrical Code, ANSI/NFPA 70, provides information with regard to proper grounding of the mast and supporting structure, grounding of the lead-in wire to an antenna discharge unit, size of grounding conductors, location of antenna-discharge unit, connection to grounding electrodes, and requirements for the grounding electrode. See Figure A.
16. Lightning – For added protection for this product during a lightning storm, or when it is left unattended and unused for long periods of time, unplug it from the wall outlet and disconnect the antenna or cable system. This will prevent damage to the product due to lightning and power-line surges.
17. Power Lines – An outside antenna system should not be located in the vicinity of overhead power lines or other electric light or power circuits, or where it can fall into such power lines or circuits. When installing an outside antenna system, extreme care should be taken to keep from touching such power lines or circuits as contact with them might be fatal.
18. Overloading – Do not overload wall outlets, extension cords, or integral convenience receptacles as this can result in a risk of fire or electric shock.
19. Object and Liquid Entry – Never push objects of any kind into this product through openings as they may touch dangerous voltage points or short-out parts that could result in a fire or electric shock. Never spill liquid of any kind on the product.
20. Servicing – Do not attempt to service this product yourself as opening or removing covers may expose you to dangerous voltage or other hazards. Refer all servicing to qualified service personnel.
21. Damage Requiring Service – Unplug this product from the wall outlet and refer servicing to qualified service personnel under the following conditions:
 - a) When the power-supply cord or plug is damaged,
 - b) If liquid has been spilled, or objects have fallen into the product,
 - c) If the product has been exposed to rain or water,
 - d) If the product does not operate normally by following the operating instructions. Adjust only those controls that are covered by the operating instructions as an improper adjustment of other controls may result in damage and will often require extensive work by a qualified technician to restore the product to its normal operation,
 - e) If the product has been dropped or damaged in any way, and
 - f) When the product exhibits a distinct change in performance – this indicates a need for service.
22. Replacement Parts – When replacement parts are required, be sure the service technician has used replacement parts specified by the manufacturer or have the same characteristics as the original part. Unauthorized substitutions may result in fire, electric shock, or other hazards.
23. Safety Check – Upon completion of any service or repairs to this product, ask the service technician to perform safety checks to determine that the product is in proper operating condition.
24. Wall or Ceiling Mounting – The product should be mounted to a wall or ceiling only as recommended by the manufacturer.
25. Heat – The product should be situated away from heat sources such as radiators, heat registers, stoves, or other products (including amplifiers) that produce heat.

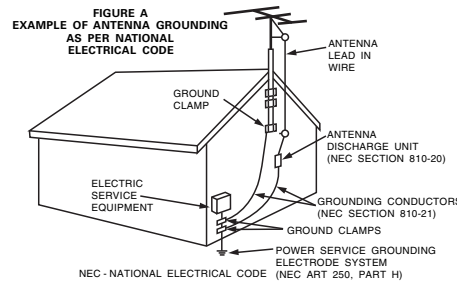

FCC INFORMATION (For US customers)

1. PRODUCT

This product complies with Part 15 of the FCC Rules. Operation is subject to the following two conditions: (1) this product may not cause harmful interference, and (2) this product must accept any interference received, including interference that may cause undesired operation.

2. IMPORTANT NOTICE: DO NOT MODIFY THIS PRODUCT

This product, when installed as indicated in the instructions contained in this manual, meets FCC requirements. Modification not expressly approved by DENON may void your authority, granted by the FCC, to use the product.

3. NOTE

This product has been tested and found to comply with the limits for a Class B digital device, pursuant to Part 15 of the FCC Rules. These limits are designed to provide reasonable protection against harmful interference in a residential installation.

This product generates, uses and can radiate radio frequency energy and, if not installed and used in accordance with the instructions, may cause harmful interference to radio communications. However, there is no guarantee that interference will not occur in a particular installation. If this product does cause harmful interference to radio or television reception, which can be determined by turning the product OFF and ON, the user is encouraged to try to correct the interference by one or more of the following measures:

- Reorient or relocate the receiving antenna.
- Increase the separation between the equipment and receiver.
- Connect the product into an outlet on a circuit different from that to which the receiver is connected.
- Consult the local retailer authorized to distribute this type of product or an experienced radio/TV technician for help.

This Class B digital apparatus complies with Canadian ICES-003.
Cet appareil numérique de la classe B est conforme à la norme NMB-003 du Canada.

NOTE ON USE / OBSERVATIONS RELATIVES A L'UTILISATION

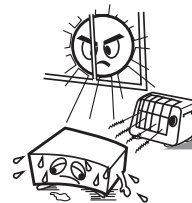

- Avoid high temperatures. Allow for sufficient heat dispersion when installed in a rack.
- Eviter des températures élevées. Tenir compte d'une dispersion de chaleur suffisante lors de l'installation sur une étagère.



- Keep the unit free from moisture, water, and dust.
- Protéger l'appareil contre l'humidité, l'eau et la poussière.



- Do not let foreign objects into the unit.
- Ne pas laisser des objets étrangers dans l'appareil.

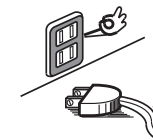

- Unplug the power cord when not using the unit for long periods of time.
- Débrancher le cordon d'alimentation lorsque l'appareil n'est pas utilisé pendant de longues périodes.

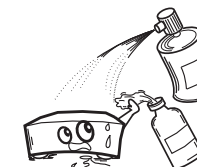

- Do not let insecticides, benzene, and thinner come in contact with the unit.
- Ne pas mettre en contact des insecticides, du benzène et un diluant avec l'appareil.



- Handle the power cord carefully. Hold the plug when unplugging the cord.
- Manipuler le cordon d'alimentation avec précaution. Tenir la prise lors du débranchement du cordon.



- * (For apparatuses with ventilation holes)
- Do not obstruct the ventilation holes.
- Ne pas obstruer les trous d'aération.



- Never disassemble or modify the unit in any way.
- Ne jamais démonter ou modifier l'appareil d'une manière ou d'une autre.

Contents

Getting Started

Accessories	2
Cautions on Handling	3
Cautions on Installation	3
About the Remote Control Unit	3
Inserting the Batteries	3
Operating Range of the Remote Control Unit	3
Part Names and Functions	4
Front Panel	4
Display	4
Rear Panel	5
Remote Control Unit	6

Connections

Preparations	7
Cables Used for Connections	7
Speaker Connections	8
Speaker Installation	8
Speaker Connections	9
Connecting Equipment with HDMI connectors	10
Connecting the Monitor	11
Connecting the Playback Components	11
DVD Player	11
CD Player	12
iPod®	12
TV/CABLE Tuner	13
Connecting the Recording Components	13
Video Cassette Recorder	13
CD Recorder / MD Recorder / Tape Deck	14
Connections to Other Devices	14
Video Camera / Game Console	14
Component with Multi-channel Output connectors	15
XM connector	15
Antenna terminals	16
Connecting the Power Cord	17
Once Connections are Completed	17

Operations

Menu Map	18
Examples of Front Display	18

System Setup

Operations	19
Example of Display of Default Values	20
Speaker Setup	20
1 ~ 6 Speaker Configuration	20
7 Subwoofer Mode Setup	20
8 ~ 15 Distance	21
16 Crossover Frequency	21
17 Test Tone	21, 22
Input Setup	22
1 , 2 HDMI In Assign	22
3 ~ 6 Digital In Assign	22
7 iPod Assign	23
8 EXT. IN Subwoofer Level	23
9 Auto Preset Memory	23
10 Antenna Aiming	23
Option Setup	24
1 Amp Assign	24
2 ~ 4 Volume Control	24
5 Auto Surround Mode	24
6 Remote ID Setup	25

Surround Modes

Standard Playback	25
Surround Playback of 2-channel Sources	25
Playing Multi-channel Sources (Dolby Digital, DTS, etc.)	26
DSP Simulation Playback	26
Stereo Playback	26
Direct Playback	26

Parameter

Surround Parameter	27
Tone Control	28
RESTORER	29
Night Mode	29

Information

1 Status	30
2 Audio Input Signal	30

Playback

Preparations 31
 Turning the Power On 31
 Selecting the Input Source 31
 Setting the Input Mode 31
 Operations During Playback 31
Playing Video and Audio Equipment 32
 Basic Operation 32
Listening to FM/AM Broadcasts 32
 Basic Operation 32
 Presetting Radio Stations (Preset Memory) 33
 Listening to Preset Stations 33
Listening to XM Satellite Radio Programs 34
 Basic Operation 34
 Checking the XM Signal Strength and Radio ID 34
 Searching Categories 35
iPod® Playback 35
 Basic Operation 35
 Listening to Music in the Browse mode 36
 Viewing Still Pictures or Videos on the iPod 36

Other Operations and Functions

Other Operations 37
 Recording on an External Device (REC OUT mode) 37
Convenient Functions 37
 Channel Level 37
 Quick Select Function 38
 Personal Memory Plus Function 38
 Last Function Memory 38
 Backup Memory 38
 Resetting the Microprocessor 38

Remote Control Unit Operations

Operating DENON Audio Components 39
Presetting 39
Operating Preset components 39 ~ 41
Punch Through Function 42

Amp Assign / Multi-zone Connections and Operations

Multi-zone Settings with the Amp Assign Function 43
Multi-zone Operations 44
 Turning the Power On and Off 44
 Selecting the Input Source 44
 Adjusting the Volume 44
 Turning off the Sound Temporarily 44

Other Information 45 ~ 51

Troubleshooting 52 ~ 54

Specifications 55

List of preset codes End of this manual

Getting Started

Thank you for purchasing this DENON product. To ensure proper operation, please read this owner's manual carefully before using the product.

After reading them, be sure to keep them for future reference.

Accessories

Check that the following parts are supplied with the product.

- ① Owner's manual 1
- ② Getting Started 1
- ③ Warranty (for North America model only) 1
- ④ Service station list 1
- ⑤ Remote control (RC-1075) 1
- ⑥ R6P/AA batteries 2
- ⑦ FM indoor antenna 1
- ⑧ AM loop antenna 1

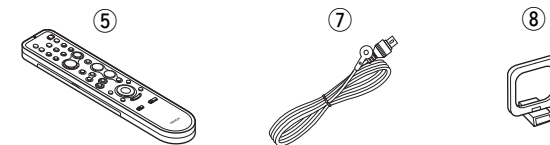

Cautions on Handling

- Before turning the power switch on**
 Check once again that all connections are correct and that there are no problems with the connection cables.
- Power is supplied to some of the circuitry even when the unit is set to the standby mode. When traveling or leaving home for long periods of time, be sure to unplug the power cord from the power outlet.
- About condensation**
 If there is a major difference in temperature between the inside of the unit and the surroundings, condensation (dew) may form on the operating parts inside the unit, causing the unit not to operate properly.
 If this happens, let the unit sit for an hour or two with the power turned off and wait until there is little difference in temperature before using the unit.
- Cautions on using mobile phones**
 Using a mobile phone near this unit may result in noise. If so, move the mobile phone away from this unit when it is in use.
- Moving the unit**
 Turn off the power and unplug the power cord from the power outlet.
 Next, disconnect the connection cables to other system units before moving the unit.
- Note that the illustrations in these instructions may differ from the actual unit for explanation purposes.

Cautions on Installation

Note:
For proper heat dispersal, do not install this unit in a confined space, such as a bookcase or similar enclosure.

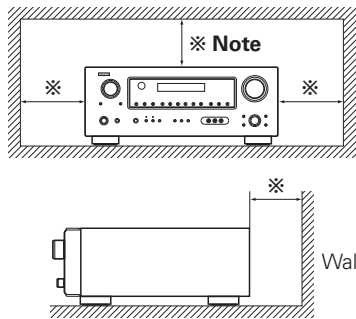

About the Remote Control Unit

In addition to the AVR-588, the included remote control unit (RC-1075) can also be used to operate the equipment listed below.

- DENON system components
- Non-DENON system components
 - By setting the preset memory (page 39 ~ 41)

Inserting the Batteries

- Lift the clasp and remove the rear lid.
- Load the two batteries properly as indicated by the marks in the battery compartment.
- Put the rear cover back on.

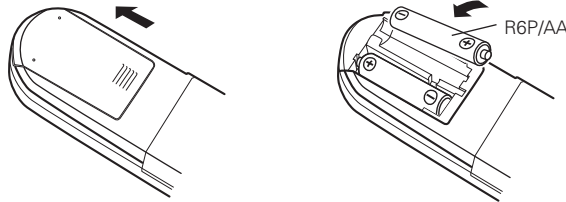

NOTE

- Replace the batteries with new ones if the set does not operate even when the remote control unit is operated close to the unit.
- The supplied batteries are only for verifying operation.
- When inserting the batteries, be sure to do so in the proper direction, following the "+" and "-" marks in the battery compartment.
- To prevent damage or leakage of battery fluid:
 - Do not use a new battery together with an old one.
 - Do not use two different types of batteries.
 - Do not attempt to charge dry batteries.
 - Do not short-circuit, disassemble, heat or dispose of batteries in flames.
- If the battery fluid should leak, carefully wipe the fluid off the inside of the battery compartment and insert new batteries.
- Remove the batteries from the remote control unit if it will not be in use for long periods.
- When replacing the batteries, have the new batteries ready and insert them as quickly as possible.

Operating Range of the Remote Control Unit

Point the remote control unit at the remote sensor when operating it.

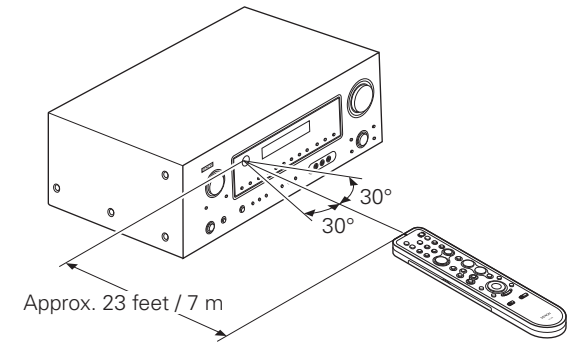

NOTE

The set may function improperly or the remote control unit may not operate if the remote control sensor is exposed to direct sunlight, strong artificial light from an inverter type fluorescent lamp or infrared light.

Part Names and Functions

For buttons not explained here, see the page indicated in parentheses ().

Front Panel

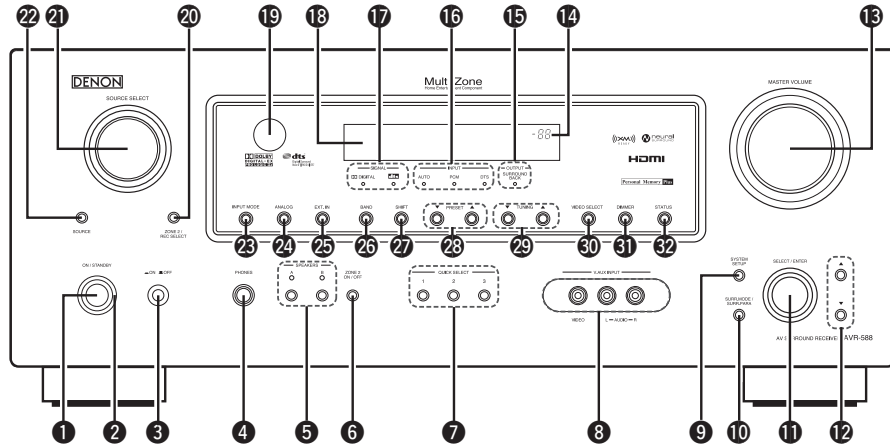

- 1 Power operation button (ON/STANDBY)** (31)
- 2 Power indicator** (31)
- 3 Power switch (ON OFF)** (31, 38)
- 4 Headphones jack (PHONES)** (32)
- 5 SPEAKER buttons** (32, 38)
- 6 ZONE2 ON/OFF button** (44)
- 7 QUICK SELECT buttons** (38)
- 8 V. AUX INPUT connectors**
Remove the cap covering the connectors when you want to use them.
- 9 SYSTEM SETUP button** (19)
- 10 SURR. MODE / SURR. PARA button** (27)
- 11 SELECT / ENTER knob** (26)
 - The **SELECT/ENTER** knob on the main unit operates in the same way as the **CURSOR** ◀ and ▶ buttons on the remote control unit.
- 12 Cursor buttons (Δ ▽)** (19)
- 13 MASTER VOLUME control knob** (31)
- 14 Master volume indicator**
- 15 SURROUND BACK indicator**
- 16 INPUT mode indicators** (31)

- 17 SIGNAL indicators**
- 18 Display**
- 19 Remote control sensor** (3)
- 20 ZONE2 / REC SELECT button** (37, 44)
- 21 SOURCE SELECT knob** (31)
- 22 SOURCE button** (31)
- 23 INPUT MODE button** (31)
- 24 ANALOG button** (31)
- 25 EXT. IN button** (31)
- 26 BAND button** (32)
- 27 SHIFT button** (33)
- 28 PRESET CHANNEL buttons** (33)
- 29 TUNING buttons** (32)
- 30 VIDEO SELECT button** (32)
- 31 DIMMER button** (32)
- 32 STATUS button** (32)

Display

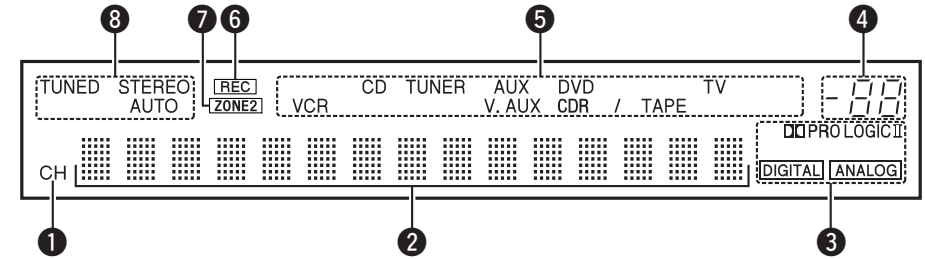

- 1 Signal channel indicator**
Lights when the preset channel is displayed at **2**.
- 2 Information display**
- 3 Input signal indicators**
- 4 Master volume indicator**
This displays the volume level.
The Setup item number is displayed in System Setup.
- 5 ZONE2 / REC OUT source indicators**
These indicators for the source selected for ZONE2/REC OUT lights.
- 6 REC indicator**
Lights while selecting the REC SELECT mode.
(Off when the "SOURCE" is selected.)
- 7 ZONE2 indicator**
This indicator lights when the ZONE2 is turned on. (Off when the "SOURCE" is selected.)
- 8 Tuner reception mode indicators**
These light according to the reception conditions when the input source is set to "TUNER":
 - **AUTO**
This lights when in the auto tuning mode.
 - **STEREO**
In the FM mode, this lights when receiving analog stereo broadcasts.
 - **TUNED**
This lights when the broadcast is properly tuned in.

Getting Started
Connections
Setup
Playback
Remote Control
Multi-Zone
Information
Troubleshooting

Rear Panel

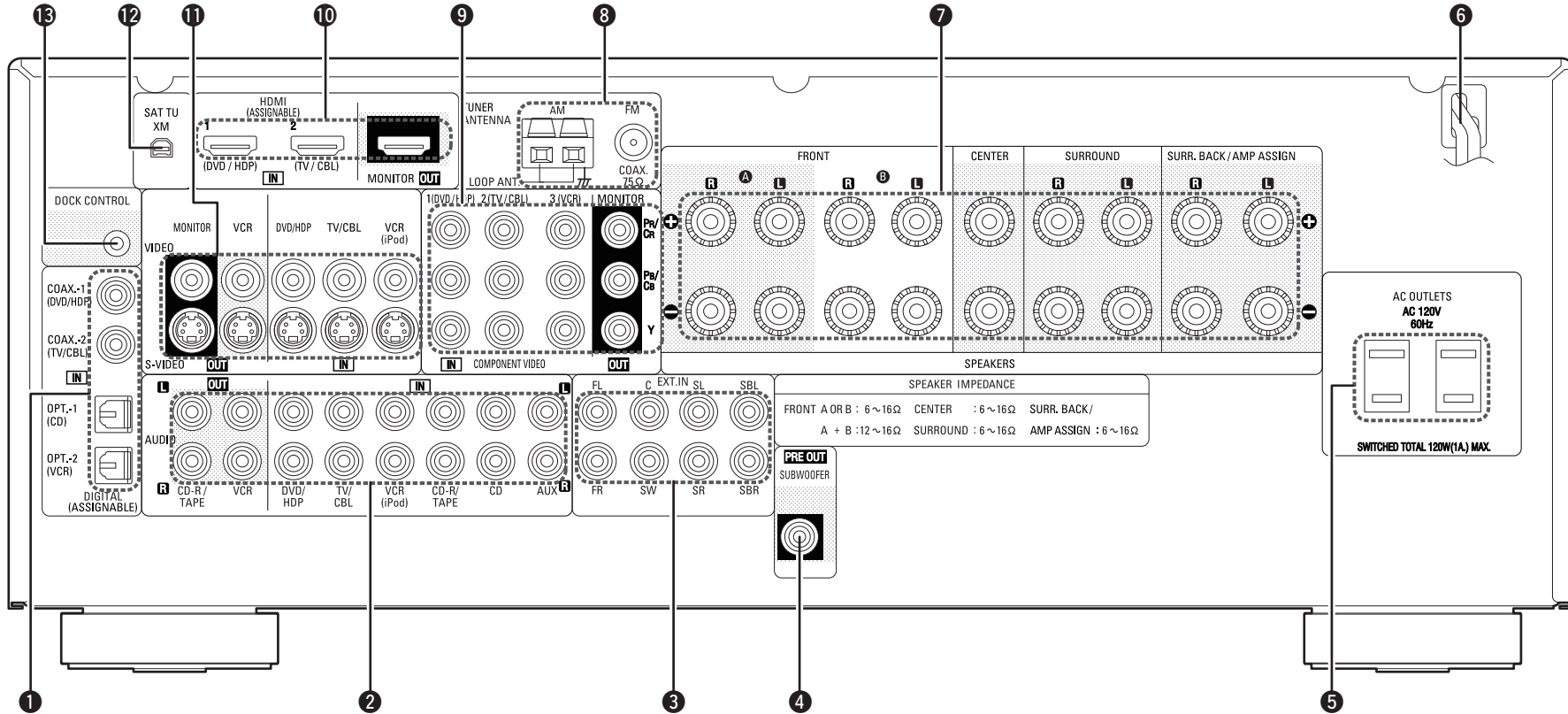

- ① Digital audio connectors (OPTICAL / COAXIAL) (11 ~ 13)
- ② Analog audio connectors (AUDIO) (11)
- ③ EXT. IN connectors (15)
- ④ PRE OUT connector (9)
- ⑤ AC OUTLETS (17)
- ⑥ Power cord (17)
- ⑦ Speaker terminals (SPEAKERS) (9, 43)
- ⑧ FM/AM antenna terminals (TUNER ANTENNA) (16)
- ⑨ COMPONENT VIDEO connectors (11)
- ⑩ HDMI connectors (10)
- ⑪ VIDEO / S-VIDEO connectors (11)
- ⑫ XM connector (SAT TU) (15)
- ⑬ DOCK CONTROL jack (12)

Getting Started
Connections
Setup
Playback
Remote Control
Multi-Zone
Information
Troubleshooting

Remote Control Unit

[Front]

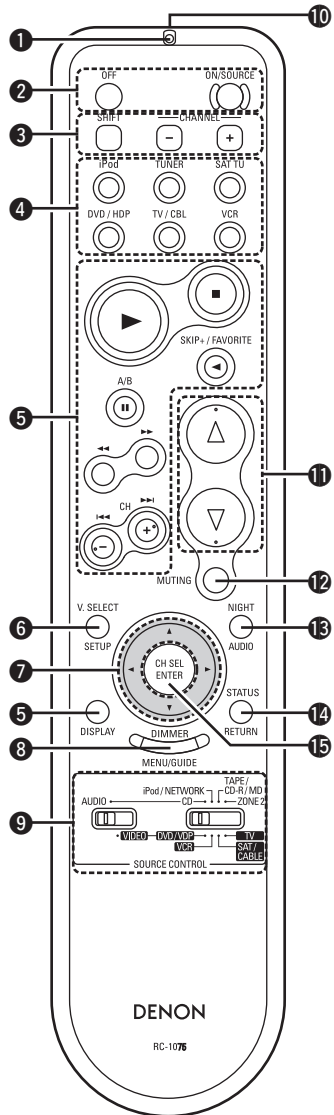

- ❶ Indicator (39)
- ❷ Power buttons (31)
- ❸ Tuner system buttons (33, 36)
- ❹ Source select buttons (31, 44)
- ❺ System buttons (36, 40)
- ❻ Video select button (V. SELECT) (32)
- ❼ Cursor buttons (Δ▽◀▶) (19, 40)
- ❽ DIMMER button (32)
- ❾ Mode selector switches (32)
- ❿ Remote control signal transmitter
- ⓫ Master volume control buttons (31, 44)
- ⓬ MUTING button (32, 44)
- ⓭ NIGHT button (29)
- ⓮ STATUS button (30)
- ⓯ Channel select (CH SEL) /
ENTER button (19, 37)

[Rear]

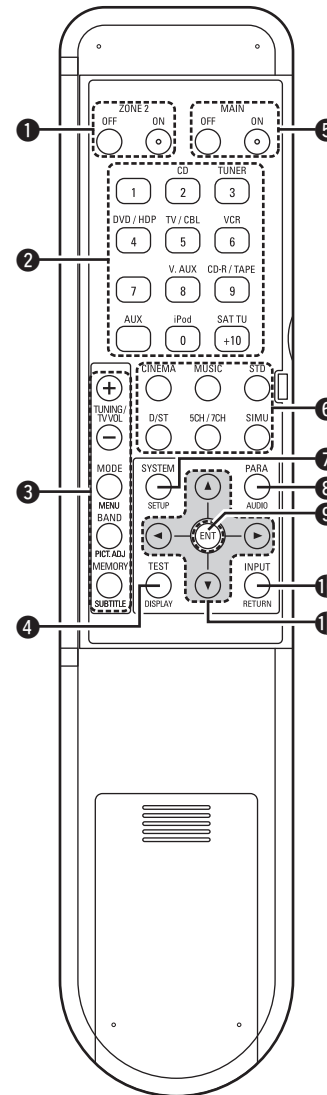

- ❶ ZONE2 power buttons (44)
- ❷ Source select buttons (31, 44)
- ❸ Tuner system buttons (32)
- ❹ Test tone button (TEST) (21, 22)
- ❺ Main zone power buttons (MAIN) (31)
- ❻ Surround mode buttons (25, 26)
- ❼ System setup button (SYSTEM) (19)
- ❽ Surround parameter button (PARA) (27)
- ❾ Enter button (ENT) (19)
- ❿ Input mode button (INPUT) (31)
- ⓫ Cursor buttons (Δ▽◀▶) (19)

NOTE

If buttons on the front or rear are pressed strongly, the button on the opposite side will be activated too.

Connections

Connections for all compatible audio and video signal formats are described in these operating instructions. Please select the types of connections suited for the equipment you are connecting. With some types of connections, certain settings must be made on the AVR-588. For details, refer to the instructions for the respective connection items below.









































NOTE

- Do not plug in the power cord until all connections have been completed.
- When making connections, also refer to the operating instructions of the other components.
- Be sure to connect the left and right channels properly (left with left, right with right).
- Do not bundle power cords together with connection cables. Doing so can result in humming or noise.

Preparations

Cables Used for Connections

Select the cables according to the equipment being connected.

Audio cables	Video cables
<p>Coaxial digital connections</p> <p>(Orange)   </p> <p>Coaxial digital (75 Ω/ohms pin-plug) cable</p> <p>Optical digital connections</p> <p>  </p> <p>Optical cable</p> <p>Analog connections (stereo)</p> <p>(White)   </p> <p>(Red)   </p> <p>Stereo pin-plug cable</p> <p>Analog connections (monaural, for subwoofer)</p> <p>(Black)   </p> <p>Pin-plug cable</p> <p>Speaker connections</p> <p>  </p> <p>Speaker cables</p>	<p>Component video connections</p> <p>(Green)    (Y)</p> <p>(Blue)    (PB/CB)</p> <p>(Red)    (PR/CR)</p> <p>Component video cable</p> <p>S-Video connections</p> <p>  </p> <p>S-Video cable</p> <p>Video connections</p> <p>(Yellow)   </p> <p>75 Ω/ohms pin-plug video cable</p>
Audio and video cables	
<p>HDMI connections</p> <p>  </p> <p>19-pin HDMI cable</p>	
Signal direction	
<p>Audio signal:</p> <p> </p> <p>Video signal:</p> <p> </p>	

Speaker Connections

Speaker Installation

The illustration below shows a basic example of installation of the amplifier combined with 8 speakers and a monitor.

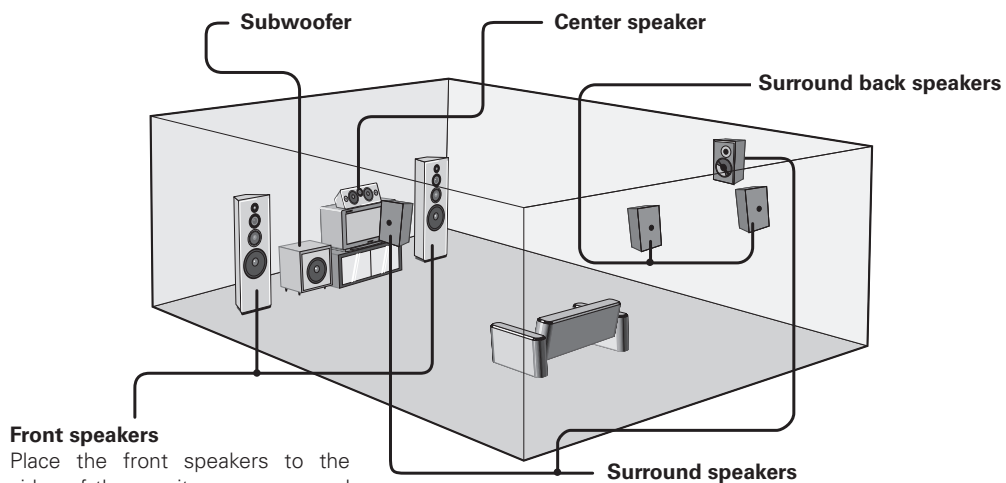

Front speakers

Place the front speakers to the sides of the monitor or screen and as flush with the screen surface as possible.



The table below shows a typical speaker configuration for the AVR-588.

	FRONT		CENTER	SURROUND		SURROUND BACK			SUBWOOFER
	L	R		L	R	L	R	1 only	
7.1-channels (FRONT A+B)	○	○	○	○	○	○	○	-	○
7.1-channels	○	○	○	○	○	○	○	-	○
6.1-channels	○	○	○	○	○	-	-	○	○
5.1-channels	○	○	○	○	○	-	-	-	○
3.1-channels	○	○	○	-	-	-	-	-	○
2.1-channels	○	○	-	-	-	-	-	-	○
2-channels	○	○	-	-	-	-	-	-	-

Speaker Connections

Example: 5.1-channels (FRONT A+B) and ZONE2 use

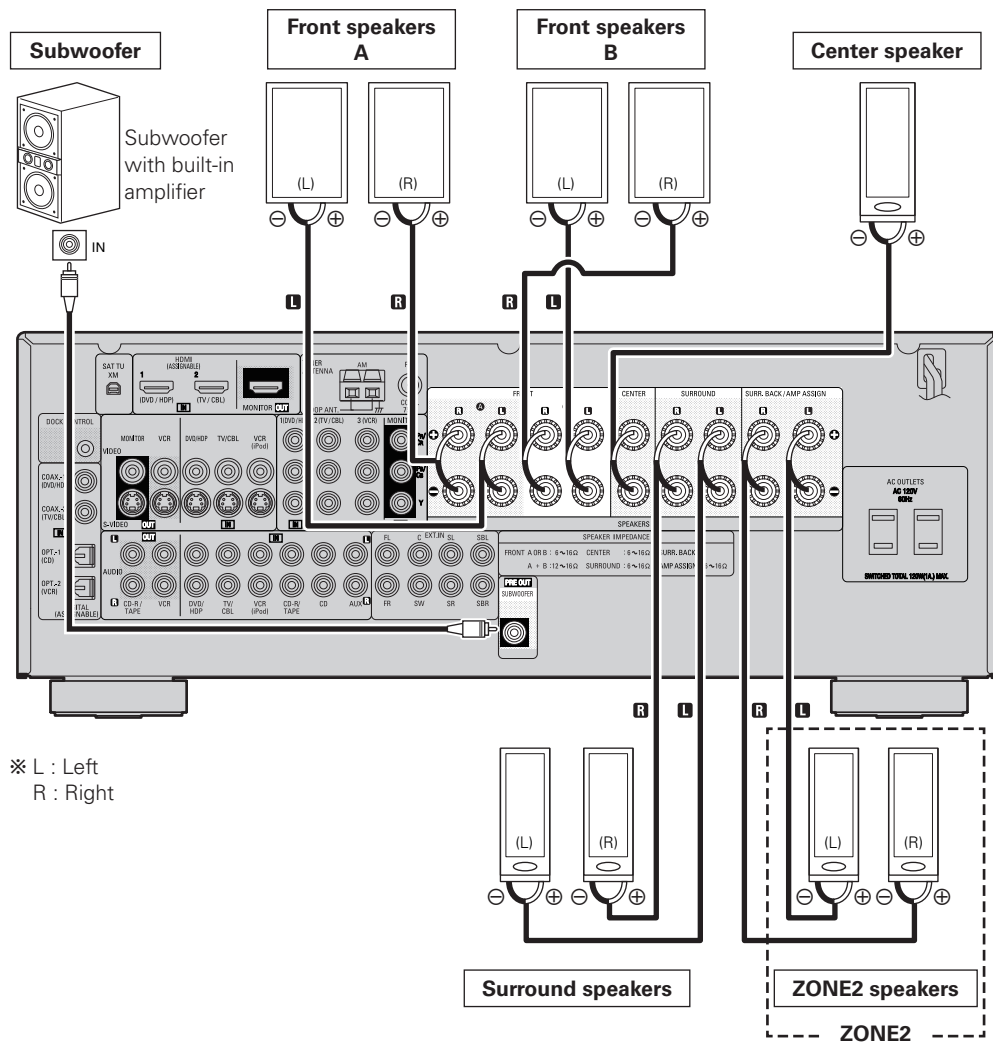

※ L : Left
R : Right



When using just one surround back speaker, connect it to the left channel (SBL).

NOTE

By default, the AVR-588's "Amp Assign" setting is set to "ZONE2". To use as the surround back speaker for the main zone, change the "Amp Assign" setting (page 24).

Connecting the Speaker Cables

Carefully check the left (L) and right (R) channels and + (red) and - (black) polarities on the speakers being connected to the AVR-588, and be sure to interconnect the channels and polarities correctly.

1 Peel off about 0.03 ft/10 mm of sheathing from the tip of the speaker cable, then either twist the core wire tightly or terminate it.



2 Turn the speaker terminal counterclockwise to loosen it.



3 Insert the speaker cable's core wire to the hilt into the speaker terminal.



4 Turn the speaker terminal clockwise to tighten it.



When using a banana plug

Tighten the speaker terminal firmly before inserting the banana plug.

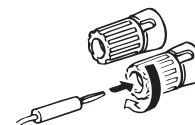

NOTE

- Use speakers with an impedance of 6 to 16 Ω/ohms. When using front A and B speakers simultaneously, use speakers with an impedance of 12 to 16 Ω/ohms.
- Connect the speaker cables in such a way that they do not stick out of the speaker terminals. The protection circuit may be activated if the core wires touch the rear panel or if the + and - sides touch each other (Protection circuit).
- Never touch the speaker terminals while the power supply is connected. Doing so could result in electric shock.

Protection circuit

If speakers with an impedance lower than specified (for example 4 Ω/ohms speakers) are used for an extended period of time with the volume turned up high, the temperature may rise, activating the protection circuit.

When the protection circuit is activated, the speaker output is shut off and the power indicator flashes red. If this happens, unplug the power cord, then check the speaker cable and input cable connections. If the set is extremely hot, wait for it to cool off and improve ventilation around it. Once this is done, plug the power cord back in and turn the set's power back on.

If the protection circuit is activated again even though there are no problems in the ventilation around the set nor in the connections, the set may be damaged. Turn the power off, then contact a DENON service center.

Connecting Equipment with HDMI connectors

With HDMI connections, the video and audio signals can be transferred with a single cable.

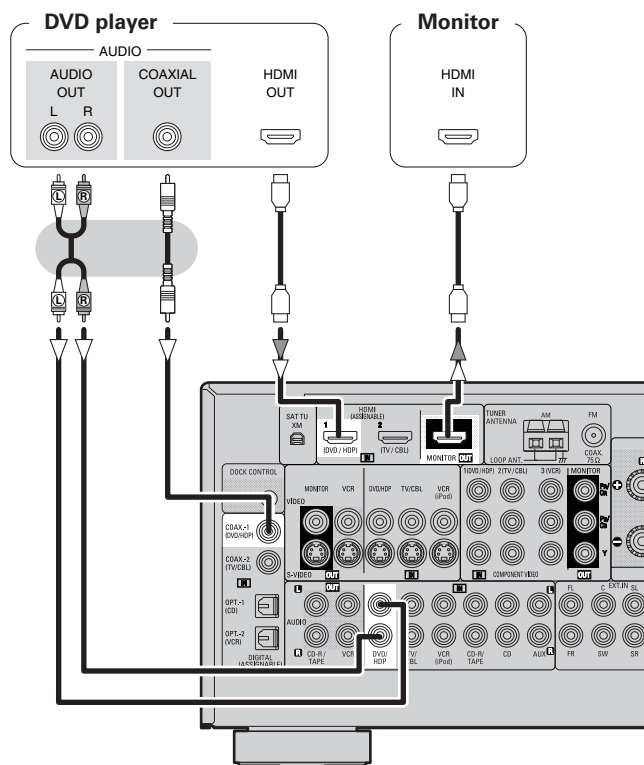

- ※ The AVR-588 is equipped for HDMI version 1.3a. This version is compatible with other versions, allowing connection to all components equipped with an HDMI connector.
- ※ The AVR-588 is compatible with 30- and 36-bit Deep Color.
- ※ The AVR-588 can be connected to a device equipped with an HDMI output connector using an HDMI cable.
- ※ The AVR-588 is compatible with HDMI Ver. 1.3a Deep Color and xvYCC.

NOTE

- The audio signal input to the HDMI input connector cannot be played on the AVR-588. Input the audio signal to the digital audio input connector or analog audio input connector.
- The AVR-588 cannot be controlled from another device via the HDMI cable.
- Video signals are not output if the input video signals do not match the monitor's resolution. In this case, switch the DVD player's resolution to a resolution with which the monitor is compatible.
- Use a cable on which the HDMI logo is indicated (a certified HDMI product) for connection to the HDMI connector. Normal playback may not be possible when using a cable other than one on which the HDMI logo is indicated (a non-HDMI-certified product).
- If the monitor or DVD player does not support Deep Color, Deep Color signal transfer is not possible.
- If the monitor or DVD player does not support xvYCC, xvYCC signal transfer is not possible.



- The audio and video signals input to the AVR-588's HDMI input connector are output unchanged from the HDMI output connector. Because of this, the sound is output from the monitor connected using the HDMI connectors, but in order to take full advantage of the AVR-588's playback sound, turn the TV's volume down.
- If the connected monitor or DVD player only has a DVI-D connector, use an HDMI/DVI converter cable. When using a DVI cable, no audio signals are transmitted.
- Use a Deep Color compatible cable for connection to Deep Color compatible devices.

When connecting with an HDMI/DVI converter cable (adapter)

- HDMI video signals are theoretically compatible with the DVI format. When connecting to a monitor, etc., equipped with a DVI-D connector, connection is possible using an HDMI/DVI converter cable, but depending on the combination of components in some cases the video signals will not be output.
- When connecting using an HDMI/DVI converter adapter, the video signals may not be output properly due to poor connections with the connected cable, etc.

Connecting the Monitor

Connect the cables to be used.

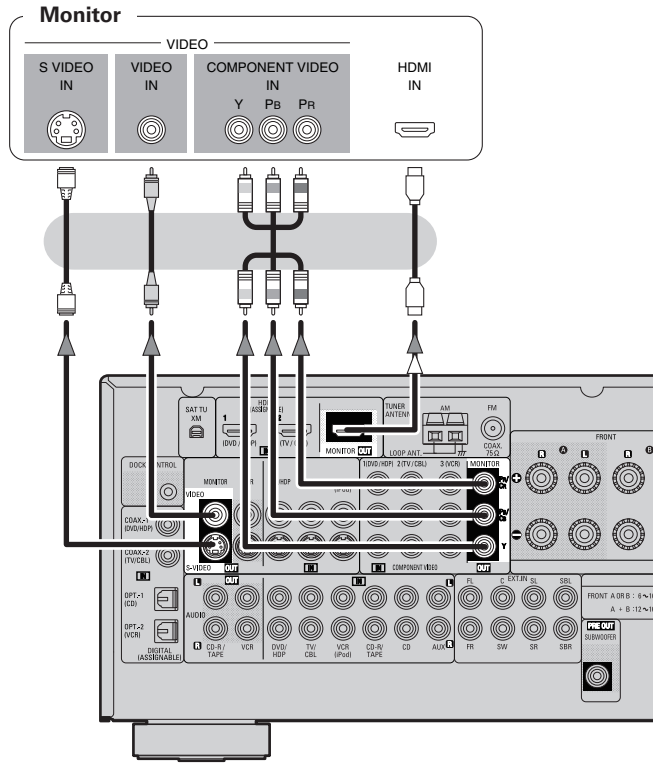

NOTE

- The component video connectors may be indicated differently on your monitor. For details, see the monitor's operating instructions.
- To play the sound by AVR-588, make analog or digital audio output connections to AVR-588's audio input connectors.
- The signals output from the HDMI connectors are only the HDMI input signals.
- AVR-588's S-Video connectors (input and output) and video connectors (input and output) have independent circuit structures, so that video signals input from the S-Video connectors are only output from the S-Video connector outputs and video signals input from the pin connectors are only output from the pin connector outputs.
- The signals input to the component (color difference) video connectors are not output from the VIDEO output connector (yellow) or the S-Video output connector.

Connecting the Playback Components

Carefully check the left (L) and right (R) channels and the inputs and outputs, and be sure to interconnect correctly.

DVD Player

- Connect the cables to be used.
- With HDMI connections, the video and audio signals can be transferred with a single cable.

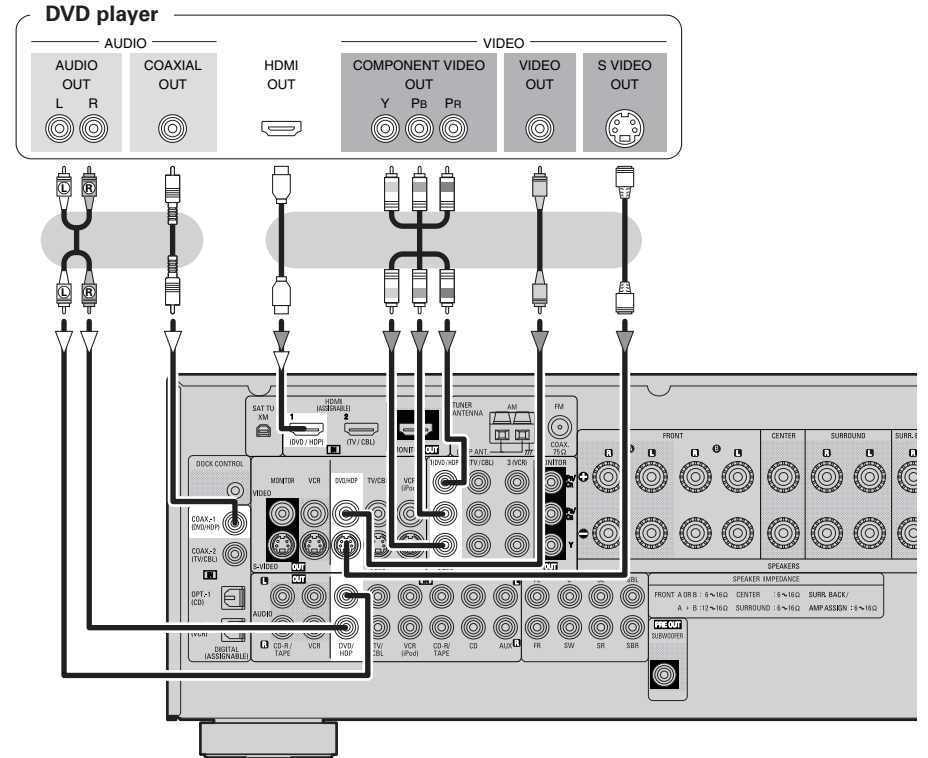

- Connect an HDP (High-Definition Player) in the same way.
- When using a optical cable for the digital audio connection, make the settings at "System Setup" – "Input Setup" – "Digital In Assign" (page 22).
- AVR-588's S-Video connectors (input and output) and video connectors (input and output) have independent circuit structures, so that video signals input from the S-Video connectors are only output from the S-Video connector outputs and video signals input from the pin connectors are only output from the pin connector outputs.
- The signals input to the component (color difference) video connectors are not output from the VIDEO output connector (yellow) or the S-Video output connector.

CD Player

Connect the cables to be used.

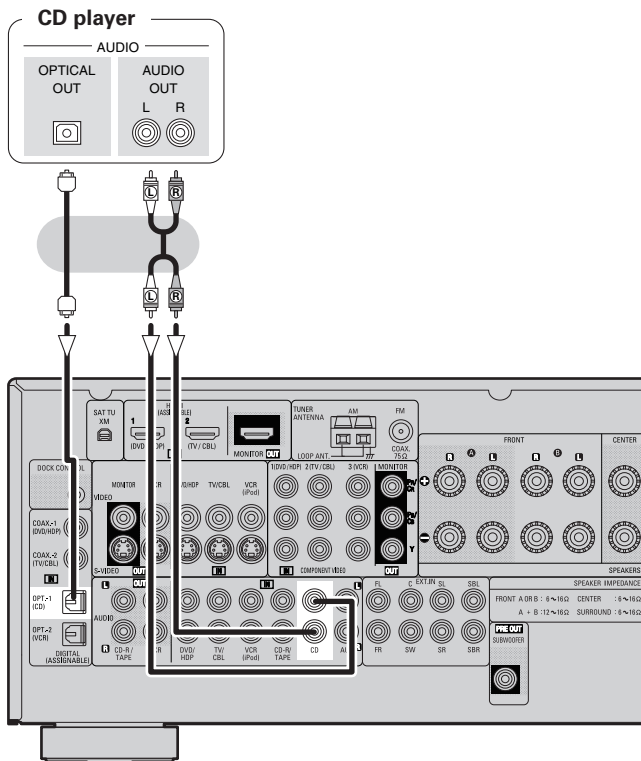

When using an coaxial cable for the digital audio connection, make the settings at "System Setup" – "Input Setup" – "Digital In Assign" (page 22).

iPod®

Use a DENON Control Dock for iPod (ASD-1R, sold separately) to connect the iPod to the AVR-588. For instructions on the Control Dock for iPod settings, refer to the Control Dock for iPod's operating instructions.

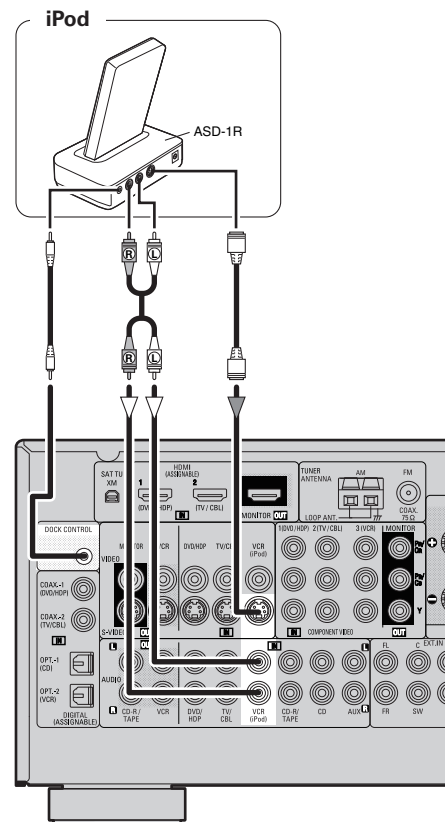

- With the default settings, the iPod can be used connected to the VCR (iPod) connector.
- To assign the iPod to a connector other than VCR (iPod), make the settings at "System Setup" – "Input Setup" – "iPod Assign" (page 23).

TV/CABLE Tuner

Connect the cables to be used.

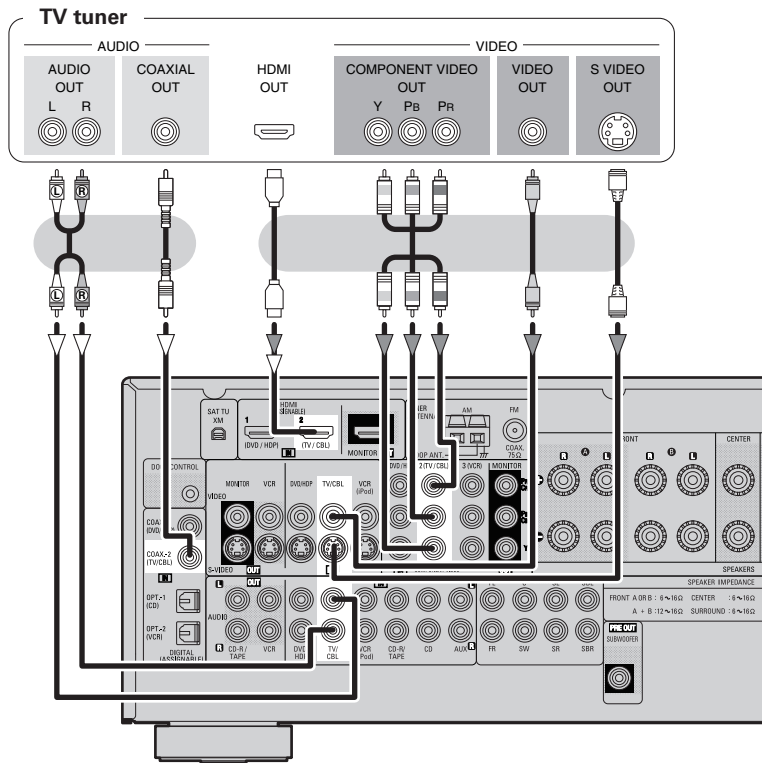

- When using an optical cable for the digital audio connection, make the settings at “System Setup” – “Input Setup” – “Digital In Assign” (page 22).
- AVR-588’s S-Video connectors (input and output) and video connectors (input and output) have independent circuit structures, so that video signals input from the S-Video connectors are only output from the S-Video connector outputs and video signals input from the pin connectors are only output from the pin connector outputs.
- The signals input to the component (color difference) video connectors are not output from the VIDEO output connector (yellow) or the S-Video output connector.

Connecting the Recording Components

Carefully check the left (L) and right (R) channels and the inputs and outputs, and be sure to interconnect correctly.

Video Cassette Recorder

Connect the cables to be used.

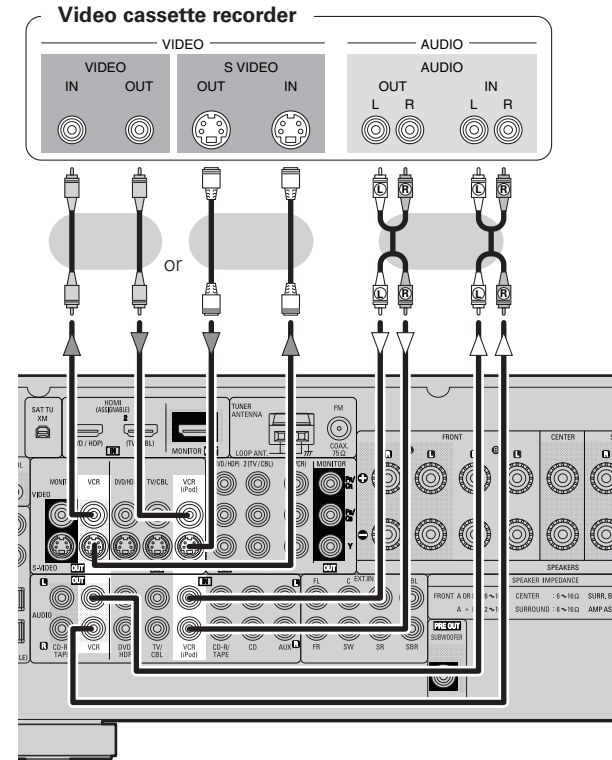

- When recording via the AVR-588, the playback device’s cable must be of the same type as the cable used to connect the AVR-588’s VCR OUT connector.
Example: TV IN → S-Video cable : VCR OUT → S-Video cable
 TV IN → Video cable : VCR OUT → Video cable
- AVR-588’s S-Video connectors (input and output) and video connectors (input and output) have independent circuit structures, so that video signals input from the S-Video connectors are only output from the S-Video connector outputs and video signals input from the pin connectors are only output from the pin connector outputs.
- The signals input to the component (color difference) video connectors are not output from the VIDEO output connector (yellow) or the S-Video output connector.

CD Recorder / MD Recorder / Tape Deck

Connect the cables to be used.

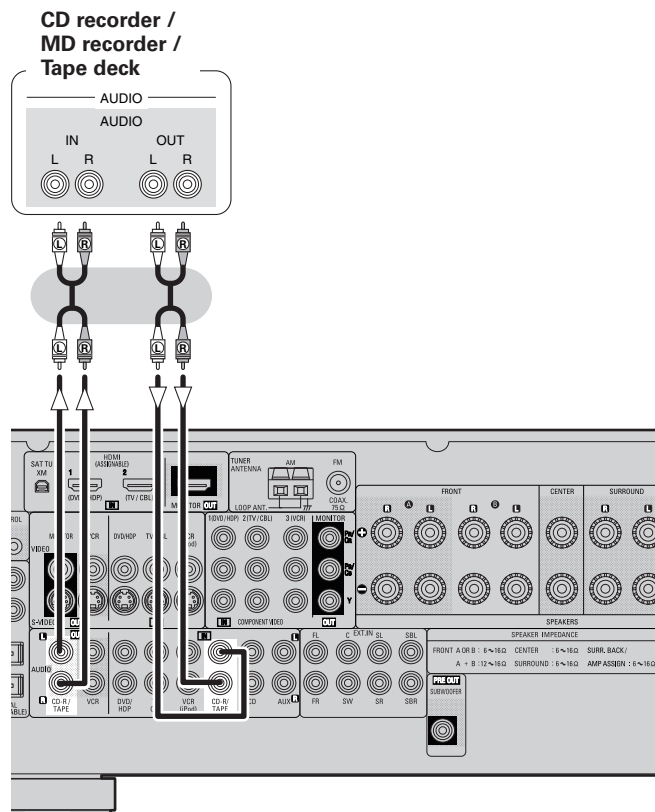

Connections to Other Devices

Carefully check the left (L) and right (R) channels and the inputs and outputs, and be sure to interconnect correctly.

Video Camera / Game Console

Connect the cables to be used.

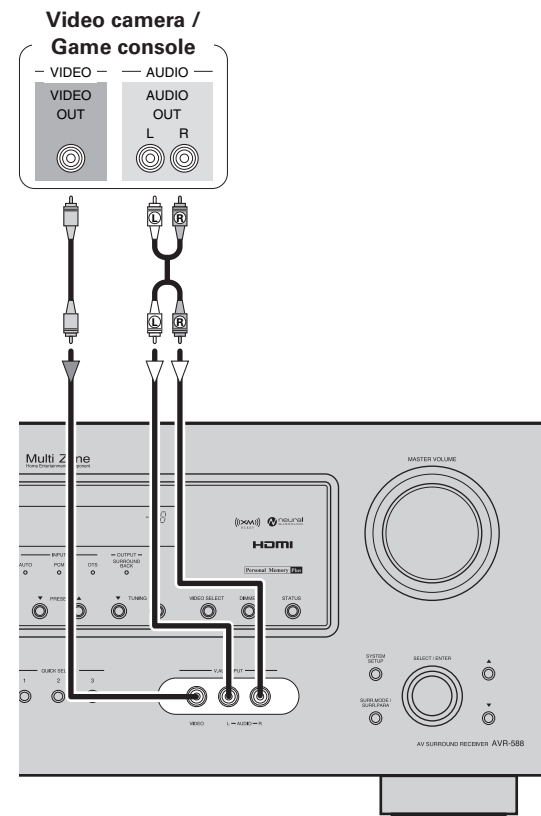

Component with Multi-channel Output connectors

Connect the cables to be used.

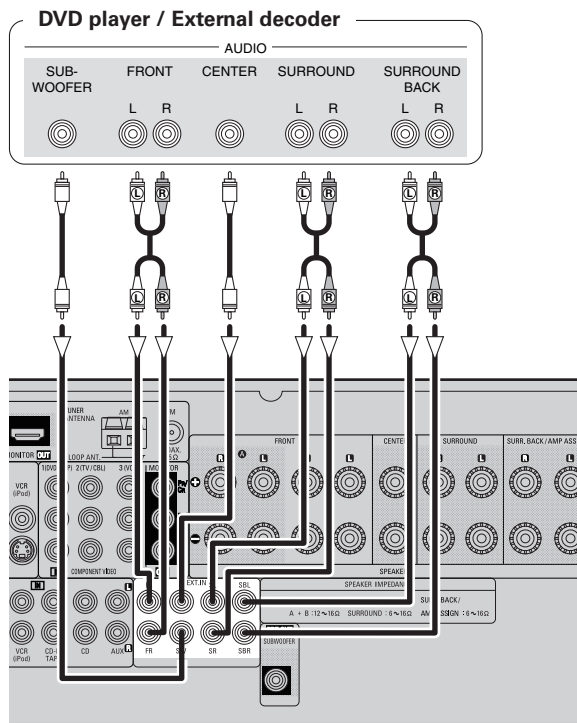

- To play the analog input signals input to the EXT. IN connectors, press the **EXT. IN** button on the main unit or the **INPUT** button on the remote control unit and select "EXT. IN" (page 31).
- The video signal can be connected in the same way as a DVD player (page 11).
- To play copyright-protected discs, connect the AVR-588's EXT. IN connector with the DVD player's analog multi-channel output connector.

XM connector

- The AVR-588 is an XM Ready® receiver. You can receive XM® Satellite Radio by connecting to the XM Mini-Tuner and Home Dock (includes home antenna, sold separately) and subscribing to the XM service.
- Plug the XM Mini-Tuner and Home Dock into the XM connector on the rear panel.
- Position the Home Dock antenna near a south-facing window to receive the best signal. For details, see "Listening to XM Satellite Radio Programs" (page 34, 35). When making connections, also refer to the operating instructions of the XM Mini-Tuner and Home Dock.

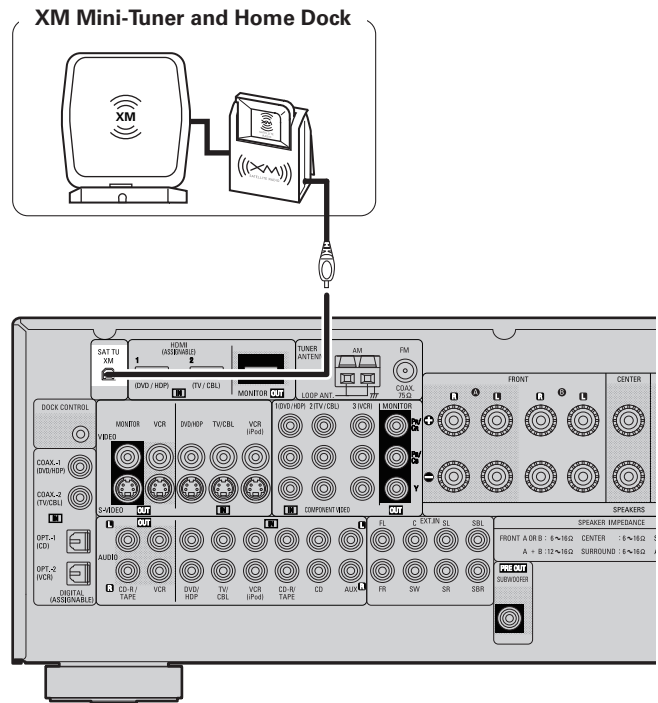

NOTE
Keep the power cord unplugged until the XM Mini-Tuner and Home Dock connection have been completed.

- The XM name and related logo are registered trademarks of XM Satellite Radio Inc. All rights reserved.
- XM Ready is a registered trademark of XM Satellite Radio Inc. All rights reserved.

Antenna terminals

An F-type FM antenna cable plug can be connected directly.

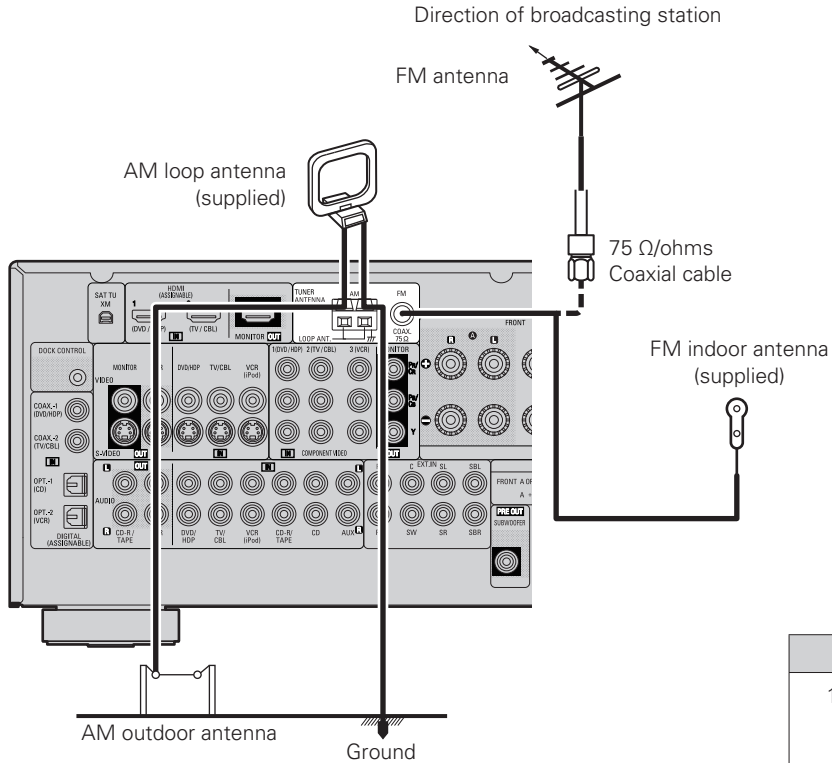

AM loop antenna assembly

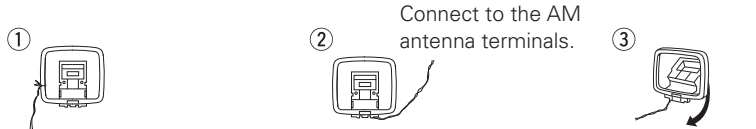

④ a. With the antenna on top of any stable surface.

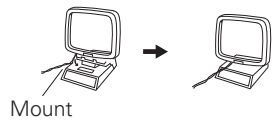

b. With the antenna attached to a wall.

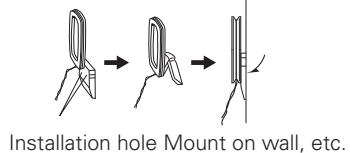

Connection of AM antennas

1. Push the lever.
2. Insert the conductor.
3. Return the lever.



NOTE

- Do not connect two FM antennas simultaneously.
- Even if an external AM antenna is used, do not disconnect the AM loop antenna.
- Make sure the AM loop antenna lead terminals do not touch metal parts of the panel.

Note to CATV system installer:

This reminder is provided to call the CATV system installer's attention to Article 820-40 of the NEC which provides guidelines for proper grounding and, in particular, specifies that the cable ground shall be connected to the grounding system of the building, as close to the point of cable entry as practical.

Connecting the Power Cord

Wait until all connections have been completed before connecting the power cord.

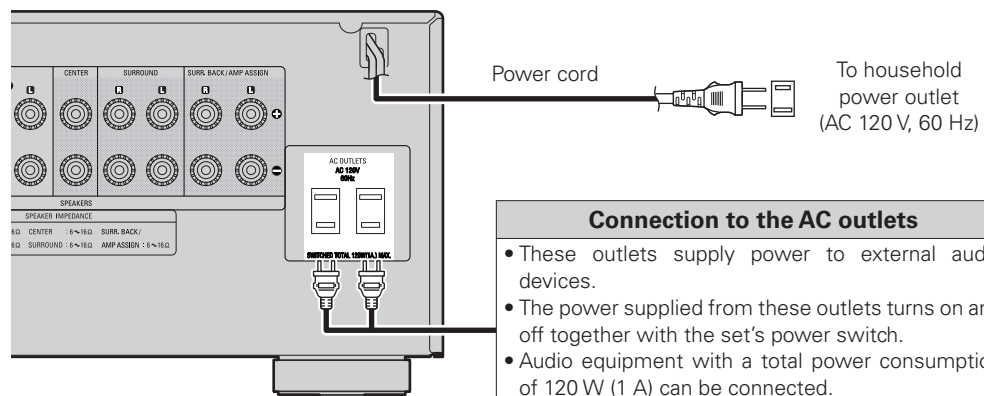

Connection to the AC outlets

- These outlets supply power to external audio devices.
- The power supplied from these outlets turns on and off together with the set's power switch.
- Audio equipment with a total power consumption of 120 W (1 A) can be connected.

NOTE

- Insert the AC plugs securely. Incomplete connections could cause noise.
- Only use the AC outlets to plug in audio devices. Do not use them as power supplies for hairdryers or anything other than audio equipment.

Once Connections are Completed

Turning the Power On (🔍 page 31)

Operations

Menu Map

System Setup (page 19 ~ 25)

- **Speaker Setup** (page 20 ~ 22)
 - Speaker Configuration
 - Subwoofer Setup
 - Distance
 - Crossover Frequency
 - Test Tone
- **Input Setup** (page 22, 23)
 - HDMI In Assign
 - Digital In Assign
 - iPod Assign
 - EXT. IN Subwoofer Level
 - Auto Preset Memory
 - Antenna Aiming
- **Option Setup** (page 24, 25)
 - Amp Assign
 - Volume Control
 - Volume Limit
 - Power On Level
 - Mute Level
 - Auto Surround Mode
 - Remote ID Setup

Parameter (page 27 ~ 29)

- **Surround Parameter**
 - MODE
 - CINEMA EQ
 - D.COMP
 - LFE
 - CENTER IMAGE
 - PANORAMA
 - DIMENSION
 - CENTER WIDTH
- DELAY TIME
- EFFECT LEVEL
- ROOM SIZE
- SB CH OUT
- SUBWOOFER ATT.
- Subwoofer
- Default
- Tone Control
 - Tone Defeat
 - Bass
 - Treble
- RESTORER
- Night Mode

Information (page 30)

- Status
- Audio Input Signal

Examples of Front Display

Some typical examples are described below.

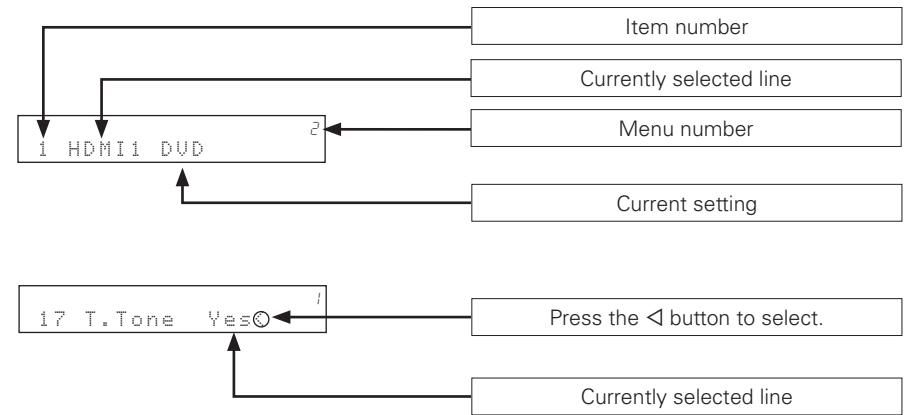

System Setup

- Make detail settings for various parameters.
- With the AVR-588, settings and operations for most functions can be performed by operating while looking at the items displayed on the main unit.

SYSTEM SETUP

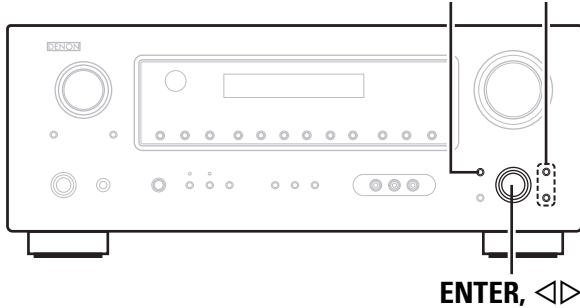

[Front]

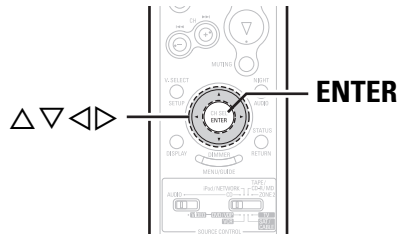



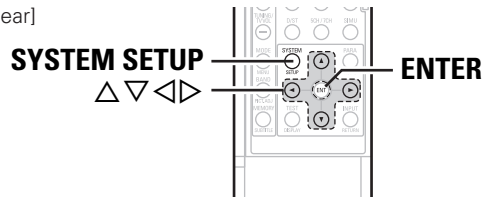



[Rear]



Operations

The same operation is possible on the main unit or remote control unit.

- 1 Press **SYSTEM SETUP**, then press **ENTER**.
"System Setup" is displayed.
- 2 Press   to select the item you want to set, then press **ENTER**.
- 3 To change the setting:
Press   to select the item you want to change, then press   to change the setting.
- 4 Press **ENTER** or  to confirm the new settings.
- 5 Press **SYSTEM SETUP** to move the next category.

※ To cancel the system setup mode, press **SYSTEM SETUP** again.

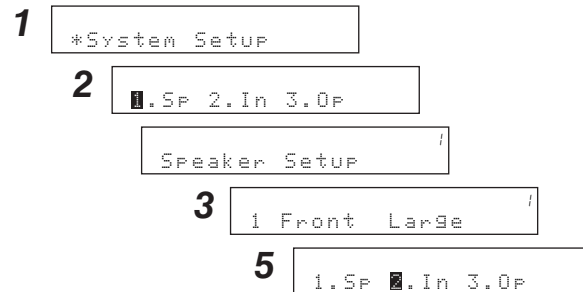

About the button names in these explanations

- < > : Buttons on the main unit
- [] : Buttons on the remote control unit

Button name only:

Buttons on the main unit and remote control unit

Example of Display of Default Values

In lists of selectable items or adjustable ranges, the item surrounded by a border is the default value.

[Selectable items] **Large** Small

Speaker Setup

Perform this setting if you wish to make the settings for your speaker systems manually.

- 1 ~ 6 Speaker Configuration
- 7** Subwoofer Mode Setup
- 8 ~ 15 Distance
- 16 Crossover Frequency
- 17 Test Tone

1 ~ 6 Speaker Configuration

Select speaker configuration and size.
(bass reproduction capability)

[Display]

```

1. Sp 2. In 3. Op
Speaker Setup
1 Front Large
...
6 Subwoofer Yes
    
```

Front Speaker

Select front speaker size.

[Selectable items] **Large** Small

Center Speaker

Select center speaker use and size.

[Selectable items] **Large** Small None

Surround Speaker

Select surround speakers use and size.

[Selectable items] **Large** Small None

Surround Back Speaker

Select surround back speaker use and size.

[Selectable items] (**Large** Small None)
(2spkrs 1spkr)

NOTE

By default, the AVR-588's "Amp Assign" setting is set to "ZONE2". To use as the surround back speaker for the main zone, change the "Amp Assign" setting (page 24).

Subwoofer

Select subwoofer use.

[Selectable items] **Yes** No

Large :Select this when using large speakers with ample low frequency reproduction capabilities.

Small :Select this when using small speakers without ample low frequency reproduction capabilities.

None :Select this when no speaker is connected.

Yes :Select this when a subwoofer is connected.

No :Select this when no subwoofer is connected.

2spkrs **1spkr** :

Select the number of surround back speakers.



- Select "Large" or "Small" not according to the physical size of the speaker but according to the low frequency reproduction capabilities based on the frequency set at "Crossover Frequency" (page 21).
- When "Front Speaker" is set to "Small"; "Subwoofer" is automatically set to "Yes".
- If "Subwoofer" is set to "No"; "Front Speaker" is automatically set to "Large".
- If "Surround Speaker" is set to "None"; "Surround Back Speaker" are automatically set to "None".
- When using just one surround back speaker, connect it to the left channel (SBL).

7 Subwoofer Mode Setup

Select low range signal to be reproduced by subwoofer.

[Display]

```

1. Sp 2. In 3. Op
Speaker Setup
7 SW Mode Norm
    
```

[Selectable items]

LFE (Normal) :Play low range and LFE signal of channels set to "Small".

LFE+Main :Play low range and LFE signal of all channels.



- This can be set when "System Setup" - "Speaker Setup" - "Subwoofer" is set to "Yes".
- Play music or a movie source and select the mode offering the strongest bass.
- Select "LFE+Main" if you want the bass signals to always be produced from the subwoofer.

Operations (page 19)

8 ~ 15 Distance

Set distance from listening position to speakers. Before making the settings, measure the distance from the listening position to the different speakers.

[Display]

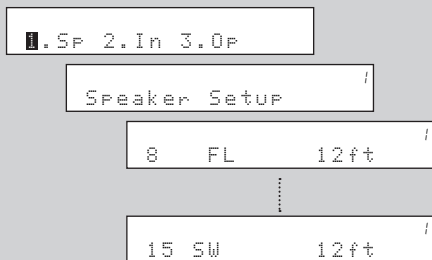

Distance measurement

Select the speaker you want to set, then set the distance. Set the value closest to the measured distance.

[Variable range]

0ft ~ 60ft : Settable in units of 1 foot.

NOTE

Set the distance between the listening position and the various speakers to no more than 20 ft.

16 Crossover Frequency

Select crossover frequency from which subwoofer handles low range signal.

[Display]

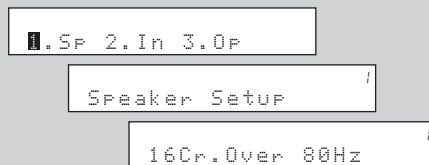

[Selectable items]

- 40Hz
- 60Hz
- 80Hz
- 90Hz
- 100Hz
- 110Hz
- 120Hz
- 150Hz
- 200Hz
- 250Hz :

Only the portion of the bass sound of the various speakers output from the subwoofer that has a frequency below the frequency set here is output. Set this according to the low frequency reproduction capabilities of the speakers you are using.



- The "Crossover Frequency" can be set when there are speakers that have been set to "Small" at "System Setup" – "Speaker Setup" or when "Subwoofer" is set to "Yes" (page 20).
- For speakers set to "Small", sound below the crossover frequency is cut from the sound output. The cut bass sound is output from the subwoofer or front speakers.
- Always set the crossover frequency to "80Hz". When using small speakers, however, we recommend setting the crossover frequency to a higher frequency.

17 Test Tone

Adjust channel levels to obtain equal volume from all speakers.

[Display]

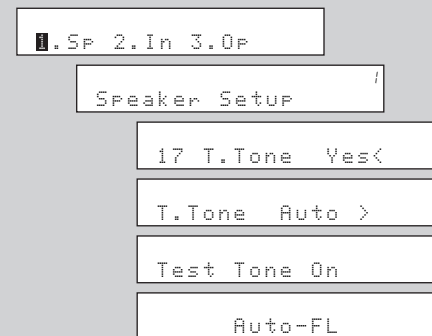

Test Tone

Select test tone playback method.

[Selectable items]

- Auto** : Automatically switch speaker from which test tone is output.
- Manual** : Manually switch speaker from which test tone is output.

Test Tone Start

Press the < button to select "Yes", then press the < > button to select "Auto" or "Manual". Then press the ∇ button. Out put the test tone.

- Auto** : Press the < > button to adjust the volume.
- Manual** : Press the Δ ∇ button to select the speaker, then press the < > button to adjust the volume.

When the adjustments are completed, press the **ENTER** button to finish the test tone.

[Variable range] **-12dB** ~ **0dB** ~ **+12dB**

Operations (page 19)

Operating from the remote control unit

Adjusting with the remote control unit using the test tones is only possible in the "Auto" mode and only effective in the STANDARD mode. The adjusted levels for the different modes are automatically stored in the memory.

[Adjusting using test tones]

- ① Press the **TEST** button.
Test tones are output from the various speakers.
- ② Use the ◀ ▶ button to adjust so that the volume is equal for all speakers.
- ③ When the adjustments are completed, press the **TEST** button again.



- When "System Setup" – "Speaker Setup" – "Surround Back Speaker" setting (👉 page 20) is set to "1spkr", the surround back speaker display is "SB".
- Speakers set to "None" in the speaker configuration settings are not displayed.
- When "Channel Level" is adjusted, the adjusted values are set for all the surround modes. To adjust the channel level separately for the different surround modes, use the operation see page 37.

Input Setup

Use this procedure to select the input source and make the settings related to playing input sources.

- 1, 2** HDMI In Assign
- 3 ~ 6** Digital In Assign
- 7** iPod Assign
- 8** EXT. IN Subwoofer Level
- 9** Auto Preset Memory
- 10** Antenna Aiming

1, 2 HDMI In Assign

Select HDMI connector to assign to this source.

[Display]

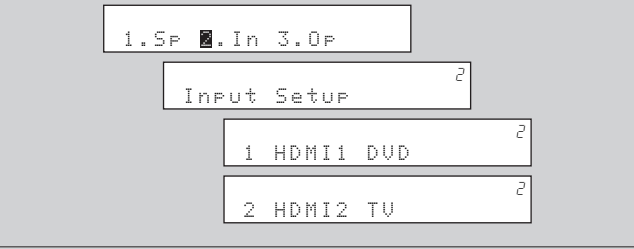

[Input terminals] **HDMI1** **HDMI2**

[Assignable input sources]

- DVD/HDP** **TV/CBL** **VCR** **V.AUX**

Input terminals	HDMI1	HDMI2
Default setting	DVD/HDP	TV/CBL



- With HDMI, the video and audio signals are transferred simultaneously. (The HDMI audio signal is output from the monitor.) At this time, set the input mode to "Auto".
- The audio signals input from the analog, digital and EXT. IN connectors are not output to the monitor.

3 ~ 6 Digital In Assign

Select digital input connector to assign to this source.

[Display]

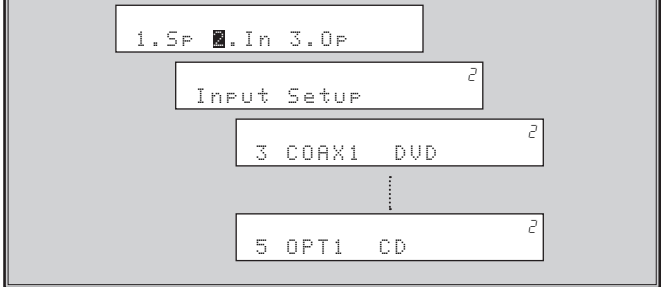

[Input terminals] **COAXIAL1** **COAXIAL2** **OPTICAL1** **OPTICAL2**

[Assignable input sources]

- CD** **AUX** **CDR** **DVD/HDP** **TV/CBL** **VCR** **V.AUX**

Input terminals	COAXIAL1	COAXIAL2	OPTICAL1	OPTICAL2
Default setting	DVD/HDP	TV/CBL	CD	VCR

Operations (👉 page 19)

7 iPod Assign

Assign Control Dock for iPod to this source.

[Display]

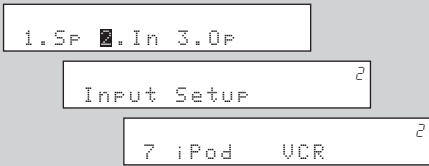

[Assignable input sources]

- CD
- AUX
- CDR
- DVD/HDP
- TV/CBL
- VCR
- V.AUX



With the default settings, the Control Dock for iPod can be used connected to the VCR (iPod) connector.

8 EXT. IN Subwoofer Level

Set the subwoofer level for playback.
Select according to the player in use.

[Display]

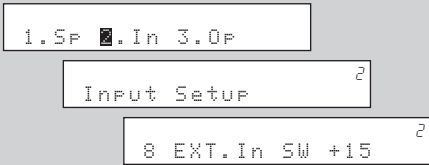

[Selectable items]

- 0dB
- +5dB
- +10dB

Select according to the player in use.

- +15dB** :

This is the recommended level.

9 Auto Preset Memory

Use the auto preset function to program radio stations.

[Display]

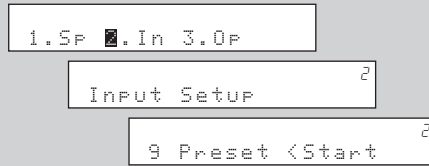

Press the ◀ button to start.

- “CH” blinks on the display and searching begins.
- “Completed” appears once searching is completed.



If an FM station cannot be preset automatically, select the desired station by tuning it in manually, then preset it manually.

10 Antenna Aiming

Adjust the XM radio reception sensitivity.

[Display]



Satellite

Indicate satellite signal strength.

Terrestrial

Indicate terrestrial signal strength.

Display	Condition
■■■■■	Signal strength is strong
■■■■	Signal strength is good
■■■	Signal strength is marginal
■■	Signal strength is weak
■	No signal

Option Setup

Make various other settings.

- 1 Amp Assign
- 2 ~ 4 Volume Control
- 5 Auto Surround Mode
- 6 Remote ID Setup

1 Amp Assign

Define how the amplifier for the surround back speaker channels is used.

[Display]

```
1.SP 2.In 0.OP
Option Setup 3
1 AMP ZONE2 3
```

The places where the surround back amplifier are used can be set freely according to the usage environment. This makes it possible to output sound to rooms other than the room (the main zone) where surround playback is performed (multi-zone playback).

[Selectable items] **7.1ch** **ZONE2**



For details, see "Amp Assign / Multi-zone Connections and Operations" (page 43).

2 ~ 4 Volume Control

Set the main zone volume setting.

[Display]

```
1.SP 2.In 0.OP
Option Setup 3
2 Limit OFF 3
3 P.On LAST 3
4 Mute FULL 3
```

Volume Limit

Make a setting for maximum volume.

[Selectable items]

- OFF** : Do not set a maximum volume.
- 20dB** : Set the maximum volume to -20 dB.
- 10dB** : Set the maximum volume to -10 dB.
- 0dB** : Set the maximum volume to 0 dB.

Power On Level

This sets the volume set when the main zone's power is turned on.

[Selectable items]

- Last** : Use the memorized setting from the last session.
- : Always use the muting on condition when power is turned on.
- 80dB ~ +18dB** : Set the volume level when the power is turned on in units of 1 dB.

Mute Level

This sets the amount of attenuation of the volume when the mute mode is set in the main zone.

[Selectable items]

- Full** : The sound is cut off entirely.
- 40dB** : The sound is attenuated by 40 dB.
- 20dB** : The sound is attenuated by 20 dB.

5 Auto Surround Mode

Make setting for memorizing surround mode setting for each input signal type.

[Display]

```
1.SP 2.In 0.OP
Option Setup 3
5 AutoSurround ON 3
```

[Selectable items]

- ON** : Memorize settings. Most recently stored surround mode is automatically selected.
- OFF** : Do not memorize settings. Surround mode does not change according to input signal.



The auto surround mode function lets you store in the memory the surround mode last used for playing the three types of input signals listed below.

- ① Analog and PCM 2-channel signals (STEREO)
 - ② 2-channel signals of Dolby Digital, DTS or other multi-channel format (DOLBY PLIIx Cinema)
 - ③ Multi-channel signals of Dolby Digital, DTS or other multichannel format (DOLBY/DTS SURROUND)
- ※ Default settings are indicated in ().

Operations (page 19)

6 Remote ID Setup

Set remote control ID.

[Display]

1.SP 2.In 3.OP

Option Setup 3

6 Remote ID 1 3

[Selectable items]

1

2

3

4

NOTE

When using the AVR-588 with only the included remote control unit (RC-1075), there is no need to make settings.

When using a separately sold remote control unit (RC-7000CI, etc.), this function can be used. Match the ID setting of the remote control unit and the receiver.

Surround Modes**Standard Playback**

This is the standard mode for enjoying surround sound according to the program source.

Surround Playback of 2-channel Sources

To select these surround modes using the **SELECT/ENTER** knob on the main unit or press the **STD** button on the remote control unit. The mode switches each time the button is pressed.

- When using a surround back speaker

[Selectable items] **DOLBY PLIIx** **DTS NEO:6** **neural**

- When not using a surround back speaker

[Selectable items] **DOLBY PLII** **DTS NEO:6** **neural**

DOLBY PLIIx or **DOLBY PLII** : The signals are decoded in DOLBY PLIIx or DOLBY PLII for playback.

→ **Cinema** : This mode is suited for movie sources.

→ **Music** : This mode is suited for music sources.

→ **Game** : This mode is suited for games.

→ **Pro Logic** : This is the Pro Logic playback mode. This can be selected when playing with a DOLBY PLII decoder. When this mode is selected, "DOLBY PL" is displayed.

DTS NEO:6 : The signals are decoded in DTS NEO:6 for playback.

→ **Cinema** : This mode is suited for movie sources.

→ **Music** : This mode is suited for music sources.

neural : It is possible to play analog input signals and PCM (2-channel, 48 kHz or less) in the surround mode.

This is the optimum mode for playing sources recorded in XM HD Surround (👉 page 34).



Select the "Cinema," "Music," "Game" and "Pro Logic" modes at "Surround Parameter" – "MODE" (👉 page 27).

Operations (👉 page 19)

Playing Multi-channel Sources (Dolby Digital, DTS, etc.)

[Selectable items]

STANDARD :

This mode is for decoding the input signals according to their format and playing surround sound.

The display when the STANDARD mode is selected depends on the input signal and surround back output playback mode.

Input signal		Display
Dolby Digital Source	DOLBY DIGITAL (other than 2ch) / DOLBY DIGITAL EX	DOLBY DIGITAL
		DOLBY DIGITAL EX
		DOLBY DIGITAL+PLIIx CINEMA DOLBY DIGITAL+PLIIx MUSIC
DTS Surround Source	DTS (5.1ch) / DTS-ES Discrete 6.1 / DTS-ES Matrix 6.1 / DTS 96/24	DTS SURROUND
		DTS+PLIIx CINEMA
		DTS+PLIIx MUSIC
		DTS+NEO:6
		DTS ES MTRX6.1 (*1)
		DTS ES DSCRT6.1 (*2)
		DTS 96/24 (*3)

*1 : This is displayed when the input signal is "DTS-ES Matrix 6.1".

*2 : This is displayed when the input signal is "DTS-ES Discrete 6.1".

*3 : This is displayed when the input signal is "DTS 96/24".



- For details, see page 50.
- To select these surround modes using the **SELECT/ENTER** knob on the main unit or press the **STD** button on the remote control unit.

DSP Simulation Playback

The desired mode according to the program source and viewing situation can be selected from among 7 DENON original surround modes.

The surround parameters can be adjusted (page 48, 49) to achieve an even more realistic, powerful sound field.

[Selectable items]

5CH / 7CH STEREO *1 : This mode is for enjoying stereo sound from all speakers.

ROCK ARENA : This mode is for enjoying the atmosphere of a live concert in an arena.

JAZZ CLUB : This mode is for enjoying the atmosphere of a live concert in a jazz club.

MONO MOVIE *2 : This mode is for playing monaural movie sources with surround sound.

VIDEO GAME : This mode is suited for achieving surround sound with video games.

MATRIX : This mode lets you add a sense of expansion to stereo music sources.

VIRTUAL : This mode is for enjoying surround effects using only the front speakers or headphones.

*1: "5CH STEREO" is displayed when "Surround Parameter" – "SB CH OUT" is set to "OFF" (page 28).

*2: When playing sources recorded in monaural in the MONO MOVIE mode, the sound will be off balance with a single channel (left or right), so input to both channels.



- To select these surround modes using the **SELECT/ENTER** knob on the main unit, press the **SIMU** button on the remote control unit. The mode switches each time the button is pressed.
- Depending on the program source being played, it may not be possible to achieve a satisfactory surround effect. In this case, try other modes to achieve a sound field suited to your tastes.

Stereo Playback

[Selectable items]

STEREO :

This is the mode for playing in stereo. The tone can be adjusted. Sound is output from the front left and right speakers and subwoofer.

Direct Playback

[Selectable items]

DIRECT :

In this mode the signals bypass the tone adjustment circuitry for high quality sound.

The sound is output to the same channels as the input signal. The display when the DIRECT mode is selected depends on the input signal.

Input signal	Display
Analog signal / PCM (2ch) / Dolby Digital source / DTS source / Other 2-channel digital signals	DIRECT



- For details, see page 51.
- To select these surround modes using the **SELECT/ENTER** knob on the main unit, press the **D/ST** button on the remote control unit. The mode switches each time the button is pressed.

Parameter

Surround Parameter

Adjust surround sound parameters.
The adjustable parameters differ for the different surround modes (page 48, 49).

- Press the **SURR. PARA** button on the main unit or the **PARA** button on the remote control unit.
- Press the Δ ∇ button to select the item, then press the \triangleleft \triangleright button to set.

MODE

Select the mode according to the playback source.

In the PLIIx or PLII mode

[Selectable items] **CINEMA** **MUSIC** **GAME** **PL** *

*: Can be selected in the PLII mode.

In the DTS NEO:6 mode

[Selectable items] **CINEMA** **MUSIC**

CINEMA : Surround sound mode optimized for movie sources.

MUSIC : Surround sound mode optimized for music sources.

GAME : Surround sound mode optimized for games.

PL : Dolby Pro Logic playback mode.



The MUSIC mode is also effective for movie sources including a lot of stereo music.

CINEMA EQ

Soften the treble range of movie soundtracks for better understanding.

[Selectable items]

ON : CINEMA EQ is used.

OFF : CINEMA EQ is not used.

D.COMP

Compress dynamic range (difference between loud and soft sounds).

[Selectable items]

OFF : Turn dynamic range compression off.

LOW : Low setting.

MID : Middle setting.

HIGH : High setting.



When playing DTS sources, this is only displayed for compatible software.

LFE

Adjust the low-frequency effects level (LFE).

[Variable range] **-10dB** ~ **0dB**



For proper playback of the different program sources, we recommend setting to the values below.

- Dolby Digital sources: "0 dB"
- DTS movie sources: "0 dB"
- DTS music sources: "-10 dB"

CENTER IMAGE

Assign center channel signal to front left and right channels for wider sound.

[Variable range] **0.0** ~ **0.3** ~ **1.0**

PANORAMA

Assign front L/R signal also to surround channels, for wider sound. If the surround effect seems weak, set "PANORAMA" to "ON".

[Selectable items] **ON** **OFF**

DIMENSION

Shift sound image center to front or rear, to adjust playback balance.

[Variable range] **0** ~ **3** ~ **6**

CENTER WIDTH

Assign center channel signal to front left and right channels for wider sound.

[Variable range] **0** ~ **3** ~ **7**

DELAY TIME

Adjust delay time to control sound stage size.

[Variable range] **0 ms** ~ **30 ms** ~ **300 ms**

EFFECT LEVEL

Adjust the strength of the surround effect.

[Variable range] **1** ~ **10** ~ **15**



Set to a lower level if the positioning and sense of phase of the surround signals seems unnatural.

ROOM SIZE

Determine size of acoustic environment.

[Selectable items]

small : Simulate acoustics of a small room.

med. s

medium

med. l

large : Simulate acoustics of a large room.

NOTE

"ROOM SIZE" does not indicate the size of the room in which sources are played.

SB CH OUT (for Multi-channel sources)

Select playback mode for surround back channels.

[Selectable items]

- OFF** : No signal is played from the surround back channels.
- NON MTRX** : The same signals as those of the surround channels are output from the surround back channels.
- MTRX ON** : The surround channel signals undergo digital matrix processing and are output from the surround back channels.
- PLIIx CINEMA** *1 : Decoded in Dolby Pro Logic IIx Cinema mode, surround back signal played.
- PLIIx MUSIC** *2 : Decoded in Dolby Pro Logic IIx Music mode, surround back signal played.
- ES MTRX** *3 : DTS signal played with digital matrix processing.
- ES DSCRT** *4 : Signal included in DTS-ES Discrete 6.1-channel sources played.

*1: This can be selected when "Surround Back Speaker" is set to "2spkrs" at "System Setup" – "Speaker Setup" setting (page 20).

*2: This can be selected when "Surround Back Speaker" is set to "2spkrs" or "1spkr" at "System Setup" – "Speaker Setup" setting.

*3: This can be selected when playing DTS sources.

*4: This can be selected when playing DTS sources including a discrete 6.1-channel signal identification signal.

SB CH OUT (for 2-channel sources)

Determine whether to use surround back speakers.

[Selectable items]

- ON** : The surround back channel signal is played.
- OFF** : The surround back channel signal is not played.

SUBWOOFER ATT.

Attenuate subwoofer level when using EXT. IN mode.

[Selectable items]

- ON** : The input from the subwoofer channel is attenuated.
- OFF** : The input from the subwoofer channel is not attenuated. Usually use in this mode.



Set this to "ON" if the subwoofer channel level seems too high when playing audio signal.

Subwoofer

Turn subwoofer output on and off.

[Selectable items]

- ON** : The subwoofer is used.
- OFF** : The subwoofer is not used.

Default

Resets the settings to the default values.

Tone Control

Adjust the tonal quality of the sound.

Tone Defeat

Turn tone adjustments off.

[Selectable items]

- ON** : Playback without tone adjustment.
- OFF** : Allow tone adjustment (treble, bass).



The tone cannot be adjusted when in the DIRECT mode.

Bass

Adjust low frequency range (bass).

[Variable range] **-14dB ~ 14dB**

Treble

Adjust high frequency range (treble).

[Variable range] **-14dB ~ 14dB**



"Bass" and "Treble" can be set when "Tone Defeat" is set to "OFF".

RESTORER

This function restores compressed audio signals to how they were before compression and corrects the sense of volume of the bass and treble to obtain richer playback sound.

[Selectable items]

OFF :

Do not use RESTORER.

Mode1 (RESTORER 64):

Optimized mode for compressed sources with very weak highs.

Mode2 (RESTORER 96):

Apply suitable bass and treble boost for all compressed sources.

Mode3 (RESTORER HQ):

Optimized mode for compressed sources with normal highs.

The default setting for "iPod" is "Mode3". All others are set to "OFF".

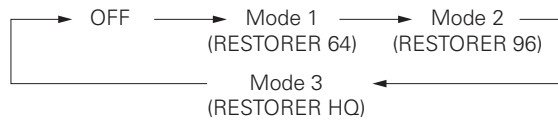

About the RESTORER function

- Such compressed audio formats as MP3, WMA (Windows Media Audio) and MPEG-4 AAC reduce the amount of data by eliminating signal components that are hard for the human ear to hear. The RESTORER function generates the signals eliminated upon compression, restoring the sound to conditions near those of the original sound before compression. It also corrects the sense of volume of the bass to obtain richer sound with compressed audio signals.
- This is displayed on the "Surround Parameter" and can be set when the input source is selected to "XM" or analog signals (including AM/FM signals) or PCM signals (fs = 44.1/48 kHz) are input.



When the surround mode is set to "neural", the "RESTORER" can not be selected.

Night Mode

Optimized setting for late-night listening.

[Selectable items]

OFF : Turn night mode off.

LOW : Low setting.

MID : Middle setting.

HIGH : High setting.



Operating from the remote control unit

Press the **NIGHT** button.

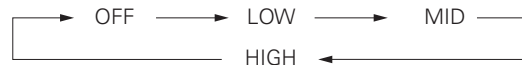

Information

Information can be called out directly by pressing the **STATUS** button.

- 1 Status
- 2 Audio Input Signal

1 Status

Shows information about settings for main zone.
The items displayed differ according to the input source.

[Items to be checked]

Surround Mode **Select Source** **Video Select**
Digital Assignment **TONE DEFEAT** **Channel Level** etc.

2 Audio Input Signal

Shows information about audio input signals.

[Items to be checked]

- Surround Mode** : The currently set surround mode is displayed.
- SIGNAL** : The input signal type is displayed.
- fs** : The input signal's sampling frequency is displayed.
- Format** : The number of channels in the input signal (front, surround, LFE) is displayed.
- Offset** : The dialogue normalization correction value is displayed.

Dialogue normalization function

This is automatically activated when playing Dolby Digital sources.
This function automatically corrects the standard signal level for individual program sources.

The correction value can be checked using the **STATUS** button.

Offset -4dB

The figure is the correction value when the standard level is corrected.

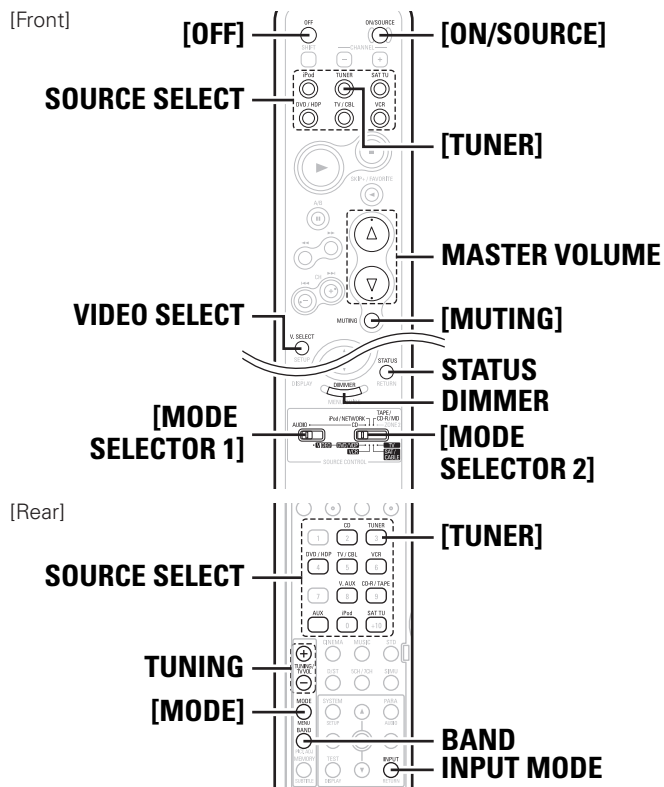
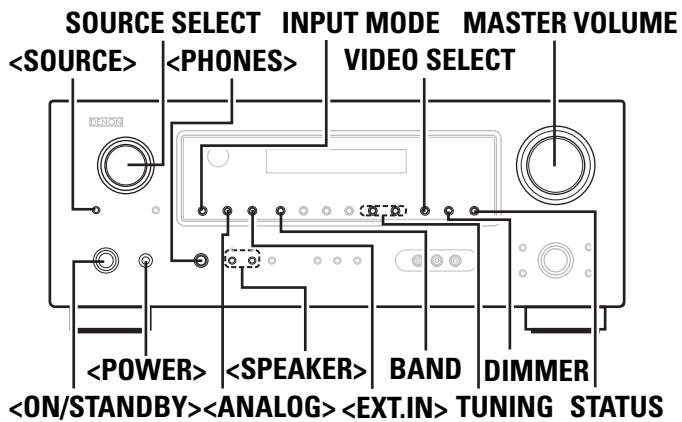

About the button names in these explanations
 < > : Buttons on the main unit
 [] : Buttons on the remote control unit
Button name only:
 Buttons on the main unit and remote control unit

Playback

Preparations

Turning the Power On

- 1 Press **<POWER>**.
The power indicator lights red and the power is set to the standby mode.
- 2 Press **<ON/STANDBY>** or **[ON/SOURCE]**.
The power indicator flashes green and the power turns on.

Turning the Power Off

- 1 Press **<ON/STANDBY>** or **[OFF]**.
The power is set to the standby mode.
- 2 Press **<POWER>**.
The power indicator turns off, and so does the power.

NOTE
 Power continues to be supplied to some of the circuitry even when the power is in the standby mode. When leaving home for long periods of time or when traveling, either press **<POWER>** to turn off the power, or unplug the power cord from the power outlet.

Selecting the Input Source

Operation on the main unit
 Turn **<SOURCE SELECT>**.

NOTE
 If "Rec Select" is selected for the input source, press **<SOURCE>** before turning **<SOURCE SELECT>**.

Operation on the remote control unit
 Press **[SOURCE SELECT]**.
 The desired input source can be selected directly.

Setting the Input Mode

Set the input mode for this source.

Press **INPUT MODE**.
 The INPUT mode indicator lights (AUTO, PCM, DTS mode).

※ Press **<ANALOG>** to select "ANALOG", **<EXT. IN>** to select "EXT. IN".

- [Selectable items]**
- AUTO** : Detect type of digital input signal and decode and play automatically.
 - PCM** : Decode and play only PCM input signals.
 - DTS** : Decode and play only DTS input signals.
 - ANALOG** : Play only signals from analog input.
 - EXT. IN** : Play only signals from EXT. IN input.

- NOTE**
- When a digital signal is properly input, the "DIGITAL" indicator lights on the display. If the "DIGITAL" indicator does not light, check the digital input connector assignment and the connections.
 - The surround mode cannot be set if the input mode is set to "EXT. IN".
 - Only set "PCM" and "DTS" when playing the respective signals.

Operations During Playback

Adjusting the Master Volume
 Either turn **<MASTER VOLUME>** or press **[MASTER VOLUME]**.

Turning Off the Sound Temporarily (Muting)

Press **[MUTING]**.



To cancel, press **[MUTING]** again. Muting can also be canceled by adjusting the master volume.

Listening with Headphones

Plug the headphones into **<PHONES>**.

The sound from the speakers and pre-out connectors is automatically cut.

NOTE

Be careful not to set the volume too high when using headphones.

Switching the front speakers

Press **<SPEAKER>**.

Video Select Function

Switch video input source while listening to audio signal.

Press **VIDEO SELECT** until the desired picture appears.

※ To cancel, press **VIDEO SELECT** to select "SOURCE".

Checking the currently playing program source, etc.

Press **STATUS**.

The current program source and various settings are indicated on the display.

For details, refer to "Information" (page 30).

Switching the brightness of the display (Dimmer)

Press **DIMMER**.



Playing Video and Audio Equipment

Basic Operation

1 Prepare the equipment.

- ① Load the DVD, CD or other software in the player.
(See the operating instructions of the respective devices.)
- ② To play a video device, switch the monitor input.
(See the monitor's operating instructions.)

2 Use **SOURCE SELECT** to select the input source.

3 Set **[MODE SELECTOR 1]** to "AUDIO" or "VIDEO". (page 39 "Remote Control Unit Operations")

4 Set **[MODE SELECTOR 2]** to the component you want to operate.

5 Start playback. (See the operating instructions of the respective devices.)

Listening to FM/AM Broadcasts

Basic Operation

1 Either turn **<SOURCE SELECT>** or press **[TUNER]** to select "TUNER".

2 Set **[MODE SELECTOR 1]** to "AUDIO". (page 39 "Remote Control Unit Operations")

3 Press **BAND** to select "FM" or "AM".

4 Tune in the desired broadcast station.

① To tune in automatically (Auto Tuning)

Press **[MODE]** to light the "AUTO" indicator on the display, then use **TUNING** to select the station you want to hear.

② To tune in manually (Manual Tuning)

Press **[MODE]** to turn off the display's "AUTO" indicator, then use **TUNING** to select the station you want to hear.



- It is also possible to switch to "FM" or "AM" in step 1 by pressing **[TUNER]**.
- If the desired station cannot be tuned in with auto tuning, tune it in manually.
- When tuning in stations manually, press and hold **TUNING** to change frequencies continuously.

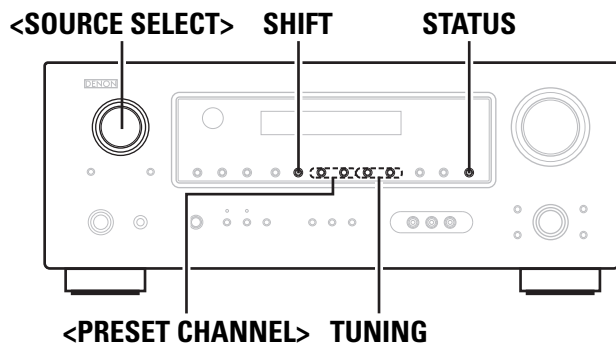

[Front]

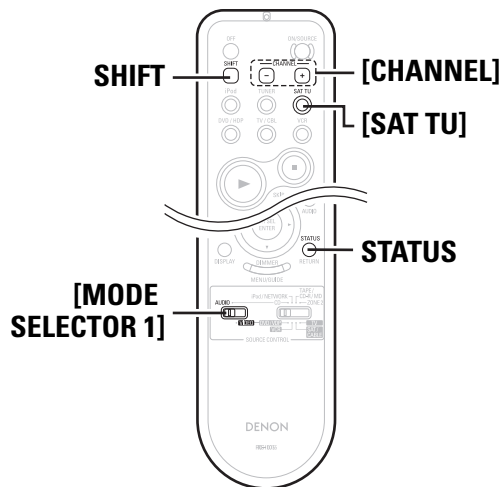

[Rear]

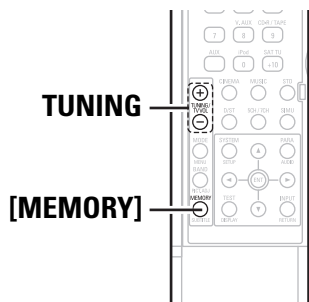

Presetting Radio Stations (Preset Memory)

Your favorite broadcast stations can be preset so that you can tune them in easily. Up to 56 stations can be preset.

- 1** Tune in the broadcast station you want to preset.
- 2** Press **[MEMORY]**.
- 3** Press **SHIFT** to select the block (A to G) in which the station is to be preset.
- 4** Press **<PRESET CHANNEL>** or **[CHANNEL]** to select the preset number (1 to 8).
- 5** Press **[MEMORY]** again to complete the setting.



- To preset other stations, repeat steps 1 to 5.
- Stations can be preset automatically at "System Setup" – "Input Setup" – "Auto Preset" (page 23).

NOTE

Preset stations are erased by overwriting them.

Listening to Preset Stations

- 1** Press **SHIFT** to select the memory block (A to G).
- 2** Press **<PRESET CHANNEL>** or **[CHANNEL]** to select the desired preset channel (1 to 8).

Default settings

Auto tuner presets	
A1 ~ A8	87.5 / 89.1 / 98.1 / 107.9 / 90.1 / 90.1 / 90.1 / 90.1 MHz
B1 ~ B8	520 / 600 / 1000 / 1400 / 1500 / 1710 kHz, 90.1 / 90.1 MHz
C1 ~ C8	90.1 MHz
D1 ~ D8	90.1 MHz
E1 ~ E8	90.1 MHz
F1 ~ F8	90.1 MHz
G1 ~ G8	90.1 MHz

About the button names in these explanations

- < > : Buttons on the main unit
- [] : Buttons on the remote control unit

Button name only:

Buttons on the main unit and remote control unit

Listening to XM Satellite Radio Programs

ABOUT XM RADIO

XM Radio offers an extraordinary variety of commercial-free music, plus the best in premier sports, news, talk radio, stand-up comedy, children’s and entertainment programming. XM is broadcast in superior digital audio from coast to coast. From rock to reggae, from classical to hip hop, XM has something for every music fan. For U.S. customers, information about XM Radio is available online at www.xmradio.com. For Canadian customers, information about XM Canada is online at www.xmradio.ca.

XM READY® LEGAL

XM monthly service subscription sold separately. XM Mini-Tuner and Home Dock required (each sold separately) to receive XM service. Installation costs and other fees and taxes, including a one-time activation fee may apply. All fees and programming subject to change. Channels with frequent explicit language are indicated with an XL. Channel blocking is available for XM radio receivers by calling 1-800-XMRADIO (US residents) and 1-877-GETXMSR (Canadian residents). For a full listing of the XM commercial-free channels and advertising-supported channels, visit lineup.xmradio.com (US residents) or xmradio.ca (Canadian residents). Subscriptions subject to Customer Agreement available at xmradio.com (US residents) and xmradio.ca (Canadian residents). Only available in the 48 contiguous United States and Canada. ©2007 XM Satellite Radio Inc. All rights reserved. All other trademarks are the property of their respective owners.

XM READY® SUBSCRIPTIONS

Once you have installed the XM Mini-Tuner Dock, inserted the XM Mini-Tuner, connected the XM Dock to your XM Ready® home audio system, and installed the antenna, you are ready to subscribe and begin receiving XM programming. There are three places to find your eight character XM Radio ID: On the XM Mini-Tuner, on the XM Mini-Tuner package, and on XM Channel 0. Record the Radio ID in the following eight squares for reference.



Note: The XM Radio ID does not use the letters “I,” “O,” “S” or “F.” Activate your XM Satellite Radio service in the U.S. online at <http://activate.xmradio.com> or call 1-800-XM-RADIO (1-800-967-2346). Activate your XM Satellite Radio service in Canada online at <https://activate.xmradio.ca> or call 1-877-GET-XMSR (1-877-438-9677). You will need a major credit card. XM will send a signal from the satellites to activate the full channel lineup. Activation normally takes 10 to 15 minutes, but during peak busy periods you may need to keep your XM Ready home audio system on for up to an hour. When you can access the full lineup on your XM Ready home audio system you are done.

Basic Operation

- 1** Either turn <SOURCE SELECT> or press [SAT TU] to select “XM”.
- 2** Set [MODE SELECTOR 1] to “AUDIO”.
(☞ page 41 “Remote Control Unit Operations”)
- 3** Use TUNING to select the station.
When the station is tuned in, the name of the track and artist are displayed.



- The channel switches continuously when **TUNING** is pressed and held.
- XM Radio stations can be preset using the same procedure as for FM/AM stations (☞ page 33 “Presetting Radio Stations (Preset Memory)” and “Listening to Preset Stations”).
- The artist name, track name, category and reception level can be checked by pressing **STATUS**.

Checking the XM Signal Strength and Radio ID

- 1** Either turn <SOURCE SELECT> or press [SAT TU] to select “XM”.
- 2** Press **STATUS** until “SIGNAL” appears on the display.
The display will switch as shown below, depending on the reception conditions.
- 3** Adjust the position of the antenna until “SIGNAL: GOOD” is shown on the display.
- 4** Press **STATUS** until the station you want to check (example: “XM001”) is displayed.
- 5** Press **TUNING** and select channel 0 (XM000).
The radio ID is shown on the display.

Display	Status
GOOD	Signal strength is good
MARGINAL	Signal strength is marginal
WEAK	Signal strength is weak
NO	No signal

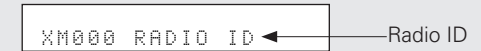

The strength of both the XM satellite and terrestrial signals can be checked at “System Setup” – “Input Setup” – “Antenna Aiming” (☞ page 23).

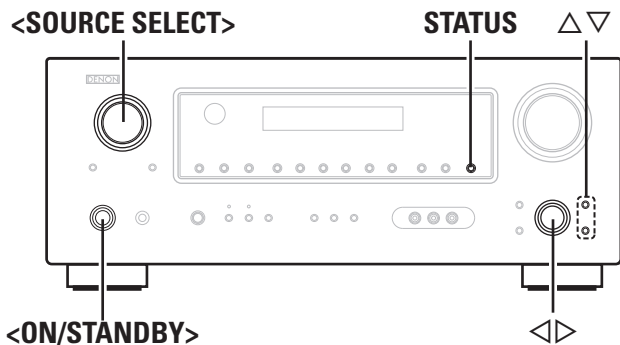

[Front]

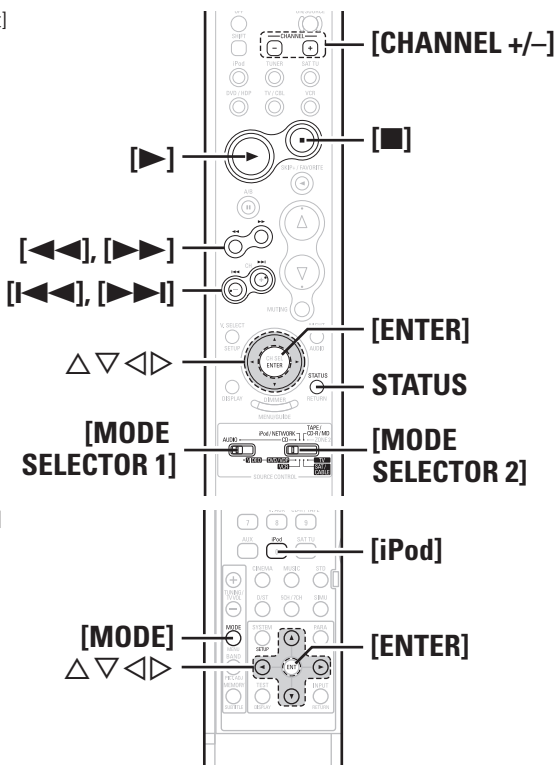

[Rear]

About the button names in these explanations

- < > : Buttons on the main unit
- [] : Buttons on the remote control unit

Button name only:

Buttons on the main unit and remote control unit

Searching Categories

1 Press < >.



2 Use < > to select the category, then use Δ ∇ to select the desired station.



- "LOADING" is displayed while stations or data are being received.
- "UPDATING" is displayed while the encoding code is being updated.
- "XM ---" is displayed if the selected channel cannot be used.

iPod® Playback

The music on an iPod can be played by using the Control Dock for iPod (ASD-1R, sold separately). The operation can also be performed using the buttons on the remote control unit.



iPod is a trademark of Apple Inc., registered in the U.S. and other countries.

※ The iPod may only be used to copy or play contents that are not copyrighted or contents for which copying or playback is legally permitted for your private use as an individual. Be sure to comply with applicable copyright legislation.

Basic Operation

1 Make the necessary preparations.

- ① Set the iPod in the DENON Control Dock for iPod.
(☞ See the Control Dock for iPod's operating instructions.)
- ② Assign the Control Dock for iPod's input.

"System Setup" – "Input Setup" – "iPod Assign"

(☞ page 23)

2 Either turn <SOURCE SELECT> or press [iPod] to select the input source assigned in step 1-② above.



※ If the displays above are not displayed, the iPod may not be properly connected. Try connecting again.

3 Set [MODE SELECTOR 1] to "AUDIO" and [MODE SELECTOR 2] to "iPod/NETWORK".

(☞ page 39 "Remote Control Unit Operations")



- With the default settings, the iPod can be used connected to the VCR (iPod) connector.
- Use the RESTORER mode to expand the low and high frequency components of compressed audio files and achieve a richer sound. The default setting is "Mode3" (☞ page 29).
- Press <ON/STANDBY> and set the AVR-588's power to the standby mode before disconnecting the iPod. Also switch the input source to one to which "iPod Assign" is not assigned before disconnecting the iPod.

NOTE

- Depending on the type of iPod and the software version, some functions may not operate.
- DENON will accept no responsibility whatsoever for any loss of iPod data.

Listening to Music in the Browse mode

- 1 Press **[MODE]** for 2 seconds or more, to change from Remote Mode to Browse Mode.

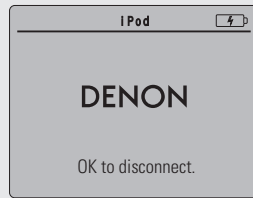

(iPod screen)

- 2 Use **[△▽]** to select the item, then press **[ENTER]** or **[▷]** to select the music file to be played.

- 3 Press **[ENTER]** or **[▷]**.
Playback starts.

Stopping playback temporarily

During playback, press **[ENTER]** or **[▷]**.
Press again to resume playback.

Fast-forwarding or fast-reversing

During playback, either press and hold **[△]** (to fast-reverse) or **[▽]** (to fast-forward), or press **[◀◀]** or **[▶▶]**.

To cue to the beginning of a track

During playback, either press **[△]** (to cue to the previous track) or **[▽]** (to cue to the next track), or press **[◀◀]** or **[▶▶]**.

To stop

During playback, either press and hold **[ENTER]** or press **[■]**.

Playing repeatedly

Press **[CHANNEL -]**.

[Selectable items] **All** **One** **OFF**

Shuffling playback

Press **[CHANNEL +]**.

[Selectable items] **Albums** **Songs** **OFF**

To switch between the Browse and Remote modes

Either press and hold **[MODE]**.



- The title name, artist name and album name can be checked by pressing **STATUS** during playback.
- On the AVR-588, folder and file names can be displayed as titles. Any characters that cannot be displayed are replaced with " . (period)".

Viewing Still Pictures or Videos on the iPod

Photo and video data on the iPod can be viewed on the monitor.
Only for iPod equipped with slideshow or video functions. (When using an ASD-1R)

- 1 Press and hold **[MODE]** to set the Remote mode.

- 2 Watching the iPod's screen, use **[△▽]** to select "Photos" or "Videos".

- 3 Press **[ENTER]** until the image you want to view is displayed.



"TV Out" at the iPod's "Slideshow Settings" or "Video Settings" must be set to "On" in order to display the iPod's photo data or videos on the monitor. For details, see the iPod's operating instructions.

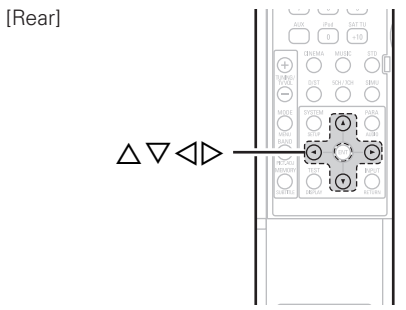
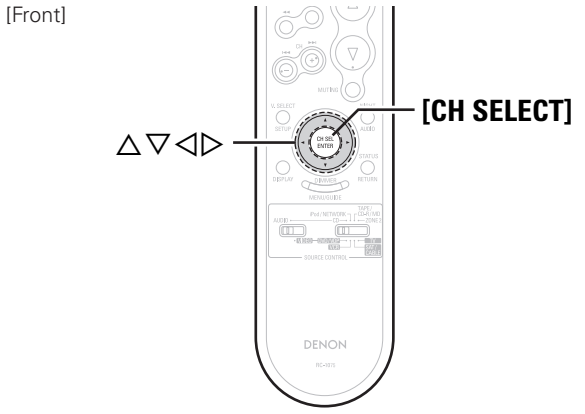
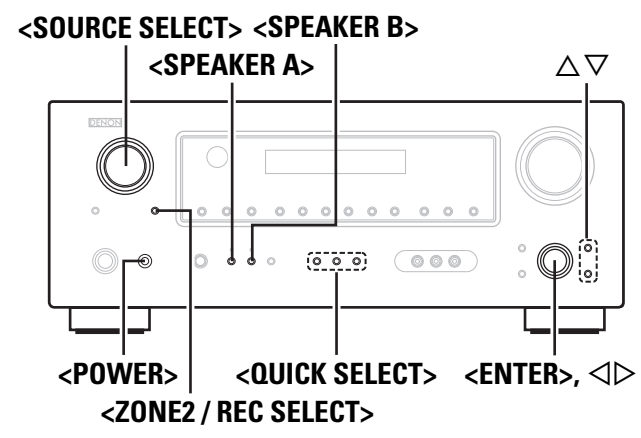

About the button names in these explanations
 < > : Buttons on the main unit
 [] : Buttons on the remote control unit
Button name only:
 Buttons on the main unit and remote control unit

Other Operations and Functions

Other Operations

Recording on an External Device (REC OUT mode)
 You can listen to one program source while recording a different program source.

- 1 Press <ZONE2 / REC SELECT> until "RECOUT" appears on the display.
 ZONE2 ↔ RECOUT
- 2 Turn <SOURCE SELECT> to choose the input source to be recorded.
 The "REC" indicator and the indicator for the selected source light.
 RECOUT SOURCE ↔ RECOUT TUNER ↔ ... ↔ RECOUT XM
- 3 Play the program source.
 For operating instructions, refer to the respective equipment's operating instructions.
 To record FM or AM broadcasts, select the broadcast (see page 32).
- 4 Start recording.
 For operating instructions, refer to the respective equipment's operating instructions.

- To cancel, press <ZONE2 / REC SELECT>, then turn <SOURCE SELECT> until "ZONE2 SOURCE" is displayed.
- Make a test recording before starting the actual recording.
- Sources selected with the REC OUT mode are output from ZONE2 as well.
- In the REC OUT mode, the remote control unit's ZONE2 mode buttons cannot be operated.

NOTE
 • Recordings you make are for your personal enjoyment and should not be used for other purposes without permission of the copyright holder.
 • Digital signals are not output from the REC OUT (CDR/TAPE and VCR) connector.

Convenient Functions

Channel Level
 You can adjust the channel level either according to the playback sources or to suit your taste, as described below.

- 1 Press <ENTER> or [CH SELECT].
 FL Vol.+ 1.5dB
- 2 Use <Δ>, <▽>, <ENTER> or [CH SELECT] to select the speaker.
 The speaker that can be set switches each time one of the buttons is pressed.
- 3 Use <Δ>, <▽> to adjust the volume.
 ※ "OFF" can be set by pressing <Δ> when the subwoofer's volume is set to -12 dB.

Quick Select Function

With this function, the currently playing input source, input mode, surround mode and volume can be stored in the memory.

- 1** Set the input source, input mode, surround mode and volume to the conditions you want to store.
- 2** Press and hold <QUICK SELECT> until “Memory” appears on the display.

[Quick Select Defaults]

	Input Source	Volume
Quick Select 1	DVD/HDP	-40 dB
Quick Select 2	TV/CBL	-40 dB
Quick Select 3	VCR	-40 dB



To call out the settings, press <QUICK SELECT> at which the desired settings were stored.

Personal Memory Plus Function

This function sets the settings (input mode, surround mode, etc.) last selected for the individual input sources.

When you switch to an input source, the settings are automatically set to the ones that were set the last time that input source was used.



The surround parameters, tone control and the volumes of the different speakers are stored for the individual surround modes.

Last Function Memory

This stores the settings as they were directly before the standby mode was set.

When the power is turned back on, the settings are restored to as they were directly before the standby mode was set.

Backup Memory

The various settings are backed up for about 1 week, even if the power is turned off or the power cord is disconnected.

Resetting the Microprocessor

Perform this procedure if the display is abnormal or if operations cannot be performed.

When the microprocessor is reset, all the settings are reset to their default values.

- 1** Turn off the power using <POWER>.
- 2** Press <POWER> while simultaneously pressing <SPEAKER A> and <SPEAKER B>.
- 3** Once the display starts flashing at intervals of about 1 second, release the two buttons.



If in step 3 the display does not flash at intervals of about 1 second, start over from step 1.

Remote Control Unit Operations

[Front]

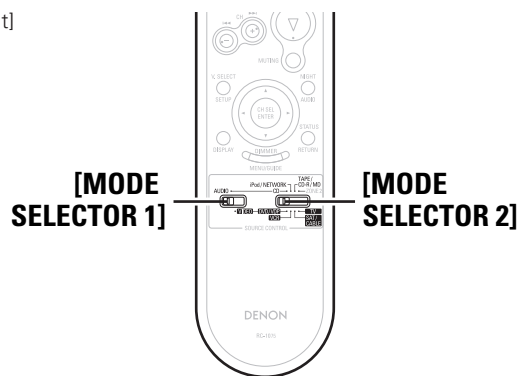

[Rear]

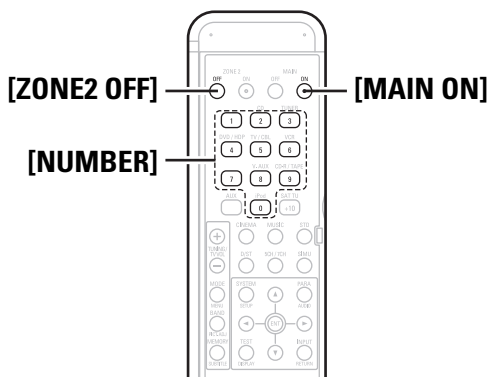

Depending on the model and year of manufacture of your equipment, some buttons may not operate.

Operating DENON Audio Components

- 1** Set [MODE SELECTOR 1] to “AUDIO”.
- 2** Set [MODE SELECTOR 2] to the position for the component to be operated (CD, iPod/NETWORK or TAPE/CD-R/MD).

- 3** Operate the audio component.
 - ※ For details, refer to the component’s operating instructions.
 - ※ While this remote control unit is compatible with a wide range of infrared controlled components, it may be the case that some component models cannot be operated with this remote control unit.

Presetting

- DENON and other makes of components can be operated by setting the preset memory.
 - Operation is not possible for some models.
- 1** Set [MODE SELECTOR 1] to “AUDIO” or “VIDEO”.
 - ※ Set to the AUDIO side for the CD, iPod/NETWORK or TAPE/CD-R/MD position, and to the VIDEO side for the DVD/VDP, VCR, SAT/CABLE or TV position.
 - 2** Set [MODE SELECTOR 2] to the component to be registered.
 - 3** Press [ZONE2 OFF] and [MAIN ON] at the same time.
 - The indicator starts flashing.
 - 4** Press [NUMBER] and input the 3-digit number of the brand of the component to be preset. The numbers are shown in the Preset Code Table (☞ End of this manual).
 - 5** To store the codes of another component in the memory, repeat steps 1 to 4.



- The signals for the pressed buttons are emitted while setting the preset memory. To avoid accidental operation, cover the remote control unit’s transmitting window while setting the preset memory.
- Depending on the model and year of manufacture, this function cannot be used for some models, even if they are of makes listed in the list of preset codes.
- Some manufacturers use more than one type of remote control code. Refer to the included list of preset codes to change the number and verify correct operation.
- The preset memory can be set for one component only among the following: TAPE/CD-R/MD, DVD/VDP and SAT/CABLE.

Operating Preset Components

- 1** Set [MODE SELECTOR 1] to “AUDIO” or “VIDEO”.
 - ※ Set to the AUDIO side for the CD, iPod/NETWORK or TAPE/CD-R/MD position, and to the VIDEO side for the DVD/VDP, VCR, SAT/CABLE or TV position.
- 2** Set [MODE SELECTOR 2] to the component you want to operate.
- 3** Operate the component.
 - ※ For details, refer to the component’s operating instructions.
 - ※ Some models cannot be operated with this remote control unit.

Functions of Buttons by Component

□ Front

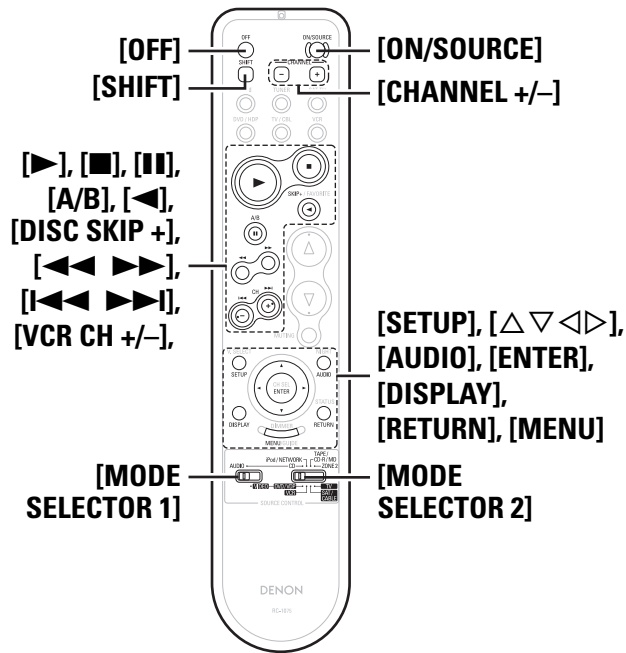

Device operated	CD Player	iPod	CD Recorder	MD Recorder	Tape Deck	DVD Player	Video disc player	Video Deck	Satellite Receiver	Cable TV	TV (Monitor)
MODE SELECTOR 1	AUDIO					VIDEO					
MODE SELECTOR 2	CD	iPod/ NETWORK	TAPE / CD-R / MD			DVD / VDP		VCR	SAT / CABLE		TV
OFF	–	–	–	–	–	Power off	–	–	–	–	–
ON/SOURCE	–	–	–	–	–	Power on	Power on / Standby	Power on / Standby	Power on / Standby	Power on / Standby	Power on / Standby
SHIFT	Preset channel selection	Preset channel selection	Preset channel selection	Preset channel selection	Preset channel selection	–	–	–	–	–	–
CHANNEL +	Preset channel selection	1-track/album shuffle play	Preset channel selection	Preset channel selection	Preset channel selection	Switch Channels (+)	Switch Channels (+)	Switch Channels (+)	Switch Channels (+)	Switch Channels (+)	Switch Channels (+)
CHANNEL -	Preset channel selection	1-track/All-track repeat play	Preset channel selection	Preset channel selection	Preset channel selection	Switch Channels (-)	Switch Channels (-)	Switch Channels (-)	Switch Channels (-)	Switch Channels (-)	Switch Channels (-)
▶	Play	Play / Pause	Play	Play	Play	Play	Play	Play	Punch through	Punch through	Punch through
■	Stop	Stop	Stop	Stop	Stop	Stop	Stop	Stop			
 , A/B	Pause	–	Pause	Pause	A/B switching	Pause	Pause	Pause			
◀, DISC SKIP +	Disc skip +	–	–	–	Reverse play	Disc skip	–	–			
◀◀ ▶▶	Manual Search (fast-reverse / fast-forward)	Manual Search (fast-reverse / fast-forward)	Manual Search (fast-reverse / fast-forward)	Manual Search (fast-reverse / fast-forward)	Rewind Fast forward	Manual Search (fast-reverse / fast-forward)	Manual Search (fast-reverse / fast-forward)	Manual Search (fast-reverse / fast-forward)			
◀◀ ▶▶, VCR CH +/-	Auto search (cue)	Auto search (cue)	Auto search (cue)	Auto search (cue)	–	Auto search (cue)	Auto search (cue)	Switch Channels (-, +)			
SETUP	–	–	–	–	–	Setup	–	–	–	–	–
△ ▽ ◀ ▶	–	Cursor	–	–	–	Cursor operation	–	–	Cursor operation	Cursor operation	Cursor operation
AUDIO	–	–	–	–	–	Switching the audio signal	–	–	–	–	–
ENTER	–	Enter	–	–	–	Enter setting	–	–	Enter setting	Enter setting	Enter setting
DISPLAY	–	–	–	–	–	Switching the display	–	–	Switching the display	Switching the display	Switching the display
RETURN	–	–	–	–	–	Return	–	–	Return	Return	Return
MENU	–	–	–	–	–	Calling out the menus	–	–	Calling out the menus	Calling out the menus	Calling out the menus

Getting Started
Connections
Setup
Playback
Remote Control
Multi-Zone
Information
Troubleshooting

□ Rear

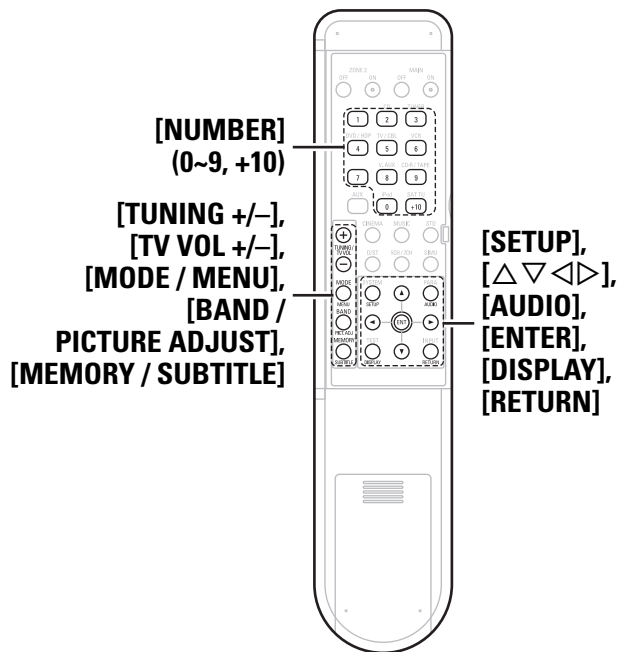

Device operated	CD Player	iPod	CD Recorder	MD Recorder	Tape Deck	DVD Player	Video disc player	Video Deck	Satellite Receiver	Cable TV	TV (Monitor)
MODE SELECTOR 1	AUDIO					VIDEO					
MODE SELECTOR 2	CD	iPod/NETWORK	TAPE / CD-R / MD			DVD / VDP		VCR	SAT / CABLE		TV
NUMBER (0 ~ 9, +10)	-	-	-	-	-	Number input / Track selection	Number input / Track selection	-	Channels	Channels	Channels
TUNING (+, -) / TV VOL (+, -)	Tuning (+, -)	Tuning (+, -)	Tuning (+, -)	Tuning (+, -)	Tuning (+, -)	Volume control (+, -)	Volume control (+, -)	Volume control (+, -)	Volume control (+, -)	Volume control (+, -)	Volume control (+, -)
MODE / MENU	Switch search modes	Switch search modes / Browse/Remote mode switching (Press and hold)	Switch search modes	Switch search modes	Switch search modes	Calling out the menus	-	-	Calling out the menus	Calling out the menus	Calling out the menus
SETUP	-	-	-	-	-	Setup	-	-	-	-	-
△ ▽ ◀ ▶	-	-	-	-	-	Cursor operation	-	-	Cursor operation	Cursor operation	Cursor operation
AUDIO BAND / PICTURE ADJUST	-	-	-	-	-	Audio	-	-	-	-	-
AM / FM switching	AM / FM switching	AM / FM switching	AM / FM switching	AM / FM switching	AM / FM switching	Picture adjust	-	-	-	-	-
ENTER	-	-	-	-	-	Enter setting	-	-	Enter setting	Enter setting	Enter setting
MEMORY / SUBTITLE	Preset memory	Preset memory	Preset memory	Preset memory	Preset memory	Subtitle	-	-	-	-	-
DISPLAY	-	-	-	-	-	Switching the display	-	-	Switching the display	Switching the display	Switching the display
RETURN	-	-	-	-	-	Return	-	-	Return	Return	Return
Default setting (Preset code)	DENON (111)	-	DENON (151)	-	-	DENON (111)	-	HITACHI (108)	-	ABC (007)	HITACHI (134)
Special Remarks	①	-	①			①, ②		①	①, ③		①, ③

[Special Remarks]

- ① Only one device can be set in the preset memory for each mode. Also, when a new code is preset, the previous code is automatically deleted.
- ② For some brands, the DVD remote control buttons may have different function names. Check beforehand.
- ③ One of the following buttons can be assigned to the TV and satellite tuner or cable TV: CD, iPod/NETWORK, TAPE/CD-R/MD, DVD/VDP, VCR (☞ page 42 "Punch Through Function").

[Front]

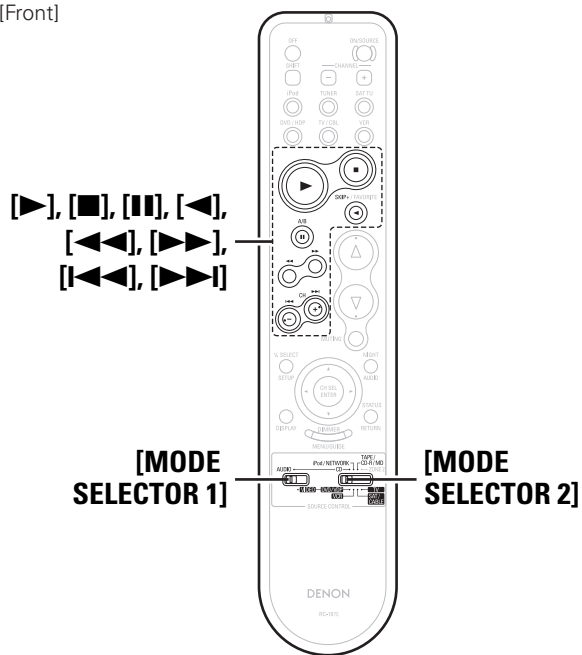

Punch Through Function

“Punch Through” is a function allowing you to operate ►, ■, ■■, ◀, ◀◀, ▶▶, ◀◀◀ and ▶▶▶ on CD, iPod/NETWORK, TAPE/CD-R/MD, DVD/VDP or VCR components when in the SAT/CABLE or TV mode. By default, nothing is set.

- 1** Set [MODE SELECTOR 1] to “VIDEO”.
- 2** Set [MODE SELECTOR 2] to the component to be registered (SAT/CABLE or TV).
- 3** Press [MEMORY] and [RETURN] at the same time. The indicator starts flashing.
- 4** Input the number of the component you want to set.

	No.
CD	1
iPod/NETWORK	2
TAPE/CD-R/MD	3
DVD/VDP	4
VCR	5
No setting	0

[Rear]

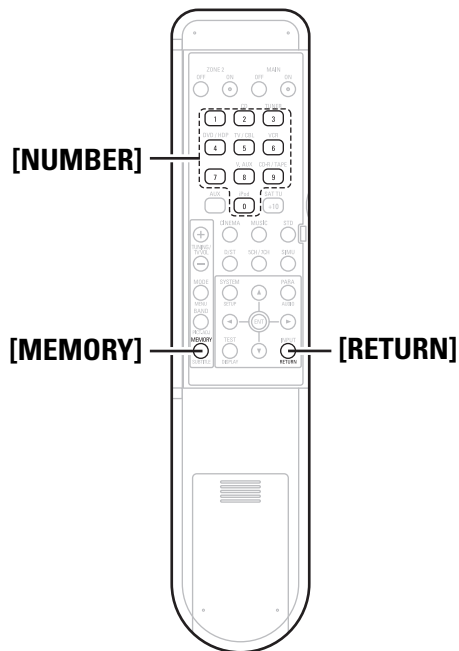

Amp Assign / Multi-zone Connections and Operations

The AVR-588 is compatible with the following types of playback:

- Multi-zone playback (ZONE2)
- 7.1-channel playback

Multi-zone Settings with the Amp Assign Function

The amp assign function lets you assign the amplifiers for the different channels built into the AVR-588 to the speaker outputs for the different zones.

Select the desired playback environment from among "Setting 1" and "Setting 2," then set the corresponding "Amp Assign" mode at "System Setup" – "Option Setup" – "Amp Assign" (page 24).

Connect the speakers as described at "Amp Assign" mode settings and speakers connected to the various speaker terminals.

Setting 1 :

● Multi-zone playback

- 5.1-channel playback + ZONE2 stereo playback
- 5.1-channel playback + ZONE2 monaural playback

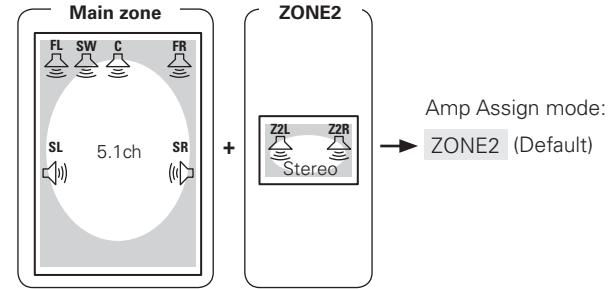

□ Amp Assign mode setting and speakers connected to the various speaker terminals

Speaker terminal	FRONT		CENTER	SURROUND		SURROUND BACK / AMP ASSIGN	
	R	L		R	L	R	L
Amp Assign mode							
ZONE2	FR	FL	C	SR	SL	Z2R	Z2L

Setting 2 :

● 7.1-channel playback

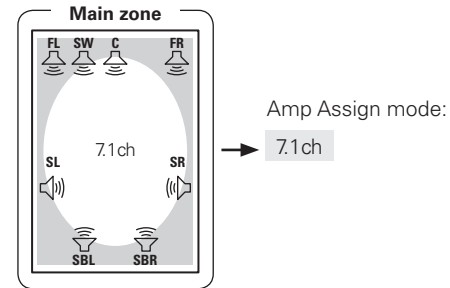

□ Amp Assign mode setting and speakers connected to the various speaker terminals

Speaker terminal	FRONT		CENTER	SURROUND		SURROUND BACK / AMP ASSIGN	
	R	L		R	L	R	L
Amp Assign mode							
7.1ch	FR	FL	C	SR	SL	SBR	SBL

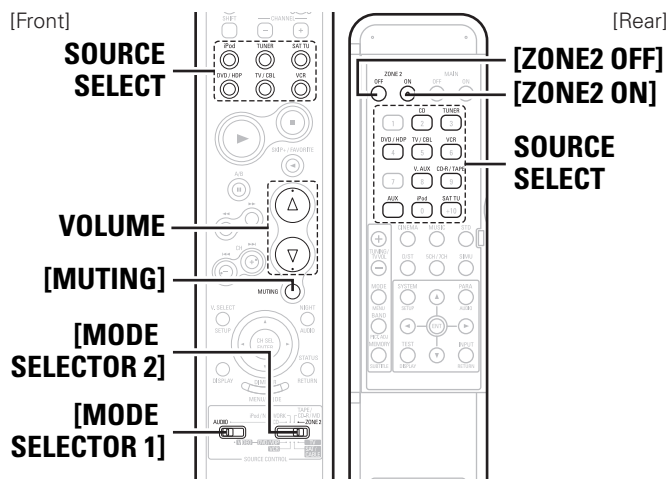
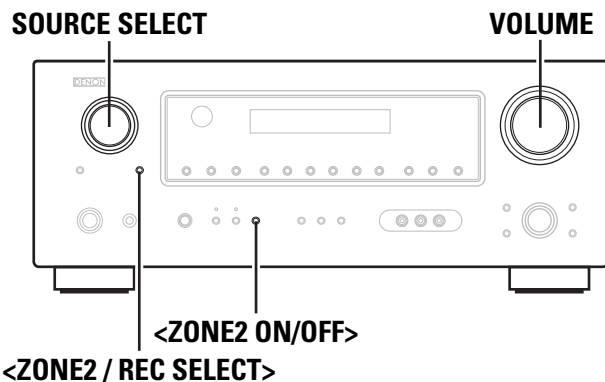

About the button names in these explanations

< > : Buttons on the main unit
 [] : Buttons on the remote control unit

Button name only:
 Buttons on the main unit and remote control unit

Multi-zone Operations

Turning the Power On and Off

[Operation on the main unit]

Press <ZONE2 ON/OFF> for the zone to be operated.

[Operation on the remote control unit]

Set [MODE SELECTOR 1] to "AUDIO" and [MODE SELECTOR 2] to "ZONE2".

Press [ZONE2 ON] or [ZONE2 OFF].

Selecting the Input Source

[Operation on the main unit]

Press <ZONE2 / REC SELECT>, then turn <SOURCE SELECT>.

[Operation on the remote control unit]

Set [MODE SELECTOR 1] to "AUDIO" and [MODE SELECTOR 2] to "ZONE2".

Press [SOURCE SELECT].

Adjusting the Volume

Set [MODE SELECTOR 1] to "AUDIO" and [MODE SELECTOR 2] to "ZONE2".

Press [VOLUME].

[Variable range] --- -70dB ~ -40dB ~ +18dB



The ZONE2 volume can be adjusted only when "ZONE2" is selected at "System Setup" – "Option Setup" – "Amp Assign" (page 24).

Turning off the Sound Temporarily

Set [MODE SELECTOR 1] to "AUDIO" and [MODE SELECTOR 2] to "ZONE2".

Press [MUTING].

※ To cancel, either adjust the volume or press [MUTING] again.

The setting is canceled when the zone's power is turned off.



The source selected for ZONE2 is also output from the recording output connectors.

NOTE

Digital audio signals input from the COAXIAL or OPTICAL connectors cannot be played in multi-zone.

Other Information

About Speaker Installation

Surround back speakers

Sound positioning directly to the rear can be achieved easily by adding a surround back speaker to a 5.1-channel system.

In addition, the acoustic image extending between the sides and the rear is narrowed, thus greatly improving the expression of the surround signals for sounds moving from the sides to the back and from the front to the point directly behind the listening position.

Change of positioning and acoustic image with 5.1-channel systems

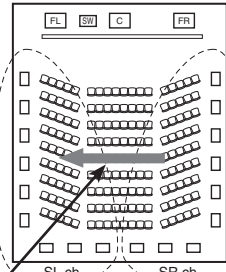

Movement of acoustic image from SR to SL

Change of positioning and acoustic image with 6.1-channel systems

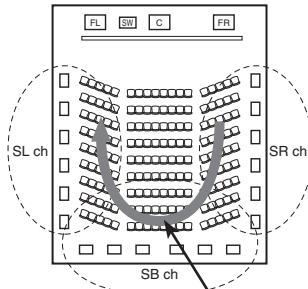

Movement of acoustic image from SR to SB to SL

In addition to sources recorded in 6.1-channels, the surround effect of conventional 2- to 5.1-channel sources can also be enhanced.

Number of surround back speakers

We recommend using 2 speakers. When using dipolar speakers in particular, be sure to use 2 speakers.

Placement of the surround left and right channels when using surround back speakers

We recommend installing the speakers for the surround "L" and "R" channels a bit forward.

Examples of speaker layouts

Below we introduce examples of speaker layouts. Refer to these to arrange your speakers according to their type and how you want to use them.

[1] Using surround back speaker(s)

① When mainly playing movies

Recommended when your surround speakers are single or 2-way speakers.

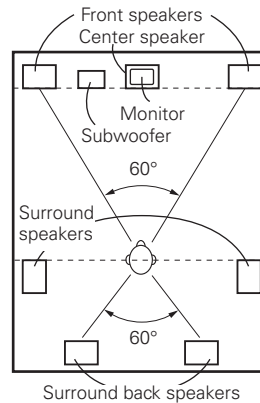

[As seen from above]

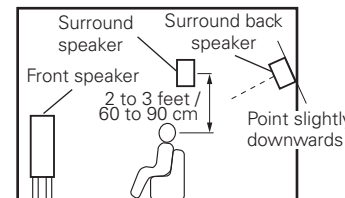

[As seen from the side]

② Setting for primarily watching movies using diffusion type speakers for the surround speakers

For the greatest sense of surround sound envelopment, diffuse radiation speakers such as bipolar types, or dipolar types, provide a wider dispersion than is possible to obtain from a direct radiating speaker (monopolar). Place these speakers at either side of the prime listening position, mounted above ear level.

Path of the surround sound from the speakers to the listening position

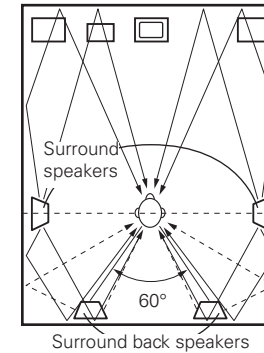

[As seen from above]

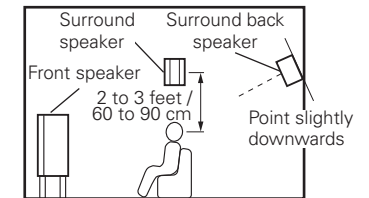

[As seen from the side]

③ When playing movies and music

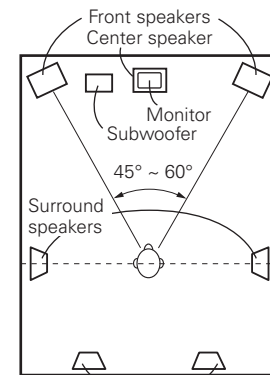

[As seen from above]

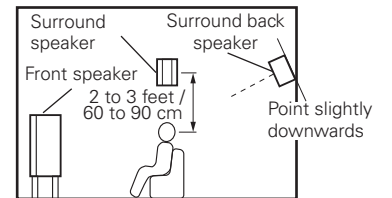

[As seen from the side]

[2] When not using surround back speakers

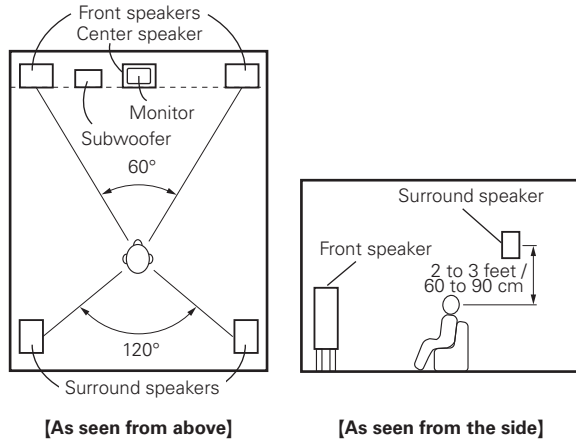

Surround

The AVR-588 is equipped with a digital signal processing circuit that lets you play program sources in the surround mode to achieve the same sense of presence as in a movie theater.

Dolby Surround

Dolby Digital

Dolby Digital is a multichannel digital signal format developed by Dolby Laboratories.

A total of 5.1-channels are played: 3 front channels ("FL", "FR" and "C"), 2 surround channels ("SL" and "SR") and the "LFE" channel for low frequencies.

Because of this, there is no crosstalk between channels and a realistic sound field with a "three-dimensional" feeling (sense of distance, movement and positioning) is achieved.

A real, overpowering sense of presence is achieved when playing movie sources in AV rooms as well.

Dolby Pro Logic II

Dolby Pro Logic II is a matrix decoding technology developed by Dolby Laboratories.

Regular music such as that on CDs is encoded into 5-channels to achieve an excellent surround effect.

The surround channel signals are converted into stereo and full band signals (with a frequency response of 20 Hz to 20 kHz or greater) to create a "three-dimensional" sound image offering a rich sense of presence for all stereo sources.

Dolby Pro Logic IIx

Dolby Pro Logic IIx is a further improved version of the Dolby Pro Logic II matrix decoding technology.

Audio signals recorded in 2-channels are decoded to achieve a natural sound with up to 7.1-channels.

There are 3 modes: "Music" suited for playing music, "Cinema" suited for playing movies, and "Game" which is optimized for playing games.

※ Sources recorded in Dolby Surround

Sources recorded in Dolby Surround are indicated with the following logo marks.

Dolby Surround support mark : 

Manufactured under license from Dolby Laboratories. "Dolby", "Pro Logic" and the double-D symbol are trademarks of Dolby Laboratories.

DTS Surround

DTS Digital Surround

DTS Digital Surround is the standard digital surround format of DTS, Inc., compatible with a sampling frequency of 44.1 or 48 kHz and up to 5.1-channels of digital discrete surround sound.

DTS-ES™ Discrete 6.1

DTS-ES™ Discrete 6.1 is a 6.1-channel discrete digital audio format adding a surround back (SB) channel to the DTS digital surround sound. Decoding of conventional 5.1-channel audio signals is also possible according to the decoder.

DTS-ES™ Matrix 6.1

DTS-ES™ Matrix 6.1 is a 6.1-channel discrete digital audio format inserting a surround back (SB) channel to the DTS digital surround sound through matrix encoding. Decoding of conventional 5.1-channel audio signals is also possible according to the decoder.

DTS NEO:6™ Surround

DTS NEO:6™ is a matrix decoding technology for achieving 6.1-channel surround playback with 2-channel sources. It includes "DTS NEO:6 CINEMA" suited for playing movies and "DTS NEO:6 MUSIC" suited for playing music.

DTS 96/24

DTS 96/24 is a digital audio format enabling high sound quality playback in 5.1-channels with a sampling frequency of 96 kHz and 24 bit quantization on DVD-Video.

Manufactured under license under U.S. Patent #'s: 5,451,942; 5,956,674; 5,974,380; 5,978,762; 6,226,616; 6,487,535; 7,003,467 & other U.S. and worldwide patents issued & pending. DTS, DTS Digital Surround, ES, and Neo:6 are registered trademarks and the DTS logos, Symbol and DTS 96/24 are trademarks of DTS, Inc.© 1996-2007 DTS, Inc. All Rights Reserved.

Neural Surround

Neural Surround™, a breakthrough in audio technology, will bring the excitement of surround music to more of America's listening audience. It provides the rich envelopment and discrete image detail of surround sound in a format 100 % compatible with stereo. With superior spectral resolution and channel separation, Neural Surround™ draws the brain's attention to sonic details in musical instruments, vocals, and ambience that are typically masked by other playback systems. This allows the listener to fully experience the richness and subtleties in recorded performance as never before. As the chosen format for XM Satellite Radio's new XM HD surround programming, Neural Surround will help deliver more surround music to more listeners than any other broadcast format. XM Satellite Radio will be the first radio company to broadcast surround sound on the radio 24 hours a day and will offer three channels fully dedicated to Neural Surround™ music. This alone will amount to more than 25,000 hours of Neural Surround™ music each year.



This product is manufactured under license from Neural Audio Corporation.

D&M Holdings Inc. hereby grants the user a non-exclusive, nontransferable, limited license right exercisable to use the NA SURROUND Technology and other US and World Wide Patents Pending technology.

"Neural" and "Neural Audio" and "Neural Surround" are trademarks of Neural Audio Corporation. All Rights Reserved.

HDMI (High-Definition Multimedia Interface)

HDMI is a digital interface standard for next generation TVs based on DVI (Digital Visual Interface) standards and optimized for use in consumer equipment.

Non-compressed digital video and multi-channel audio signals are transmitted with a single connection.

HDMI is also compatible with HDCP (High-bandwidth Digital Contents Protection), a technology for protecting copyrights that encrypts digital video signals in the same way as with DVI.

Deep Color

Eliminates on-screen color banding, for smooth tonal transitions and subtle gradations between colors.

Enables increased contrast ratio.

Can represent many times more shades of gray between black and white.

At 30-bit pixel depth, a four times improvement would be the minimum, and the typical improvement would be eight times or more.

xvYCC

Next-generation "xvYCC" color space supports 1.8 times as many colors as existing HDTV signals.

Lets HDTVs display colors more accurately.

Enables displays with natural, vivid colors.

"HDMI", "HDMI logo" and "High-Definition Multimedia Interface" are trademarks or registered trademarks of HDMI Licensing LLC.

Surround Modes and Parameters

Surround mode	Signals and adjustability in the different modes														
	Channel output					Parameter (default values are shown in parentheses)									
	Front L/R	Center	Surround L/R	Surround Back L/R	Subwoofer	D. COMP *1	LFE *2	SB CH OUT	CINEMA EQ.	MODE	ROOM SIZE	EFFECT LEVEL	DELAYTIME	Subwoofer	
DIRECT	○	×	×	×	⊙	○ (OFF)	○ (0 dB)	×	×	×	×	×	×	○	
STEREO	○	×	×	×	⊙	○ (OFF)	○ (0 dB)	×	×	×	×	×	×	×	
EXT. IN	○	⊙	⊙	⊙	⊙	×	×	×	×	×	×	×	×	×	
DOLBY PRO LOGIC IIx	○	⊙	⊙	⊙	⊙	○ (OFF)	×	○	○ (NOTE1)	○ (CINEMA)	×	×	×	×	
DOLBY PRO LOGIC II	○	⊙	⊙	×	⊙	○ (OFF)	×	○	○ (NOTE2)	○ (CINEMA)	×	×	×	×	
DTS NEO:6	○	⊙	⊙	⊙	⊙	○ (OFF)	×	○	○ (NOTE1)	○ (CINEMA)	×	×	×	×	
DOLBY DIGITAL	○	⊙	⊙	⊙	⊙	○ (OFF)	○ (0 dB)	○	○ (OFF)	×	×	×	×	×	
DTS SURROUND	○	⊙	⊙	⊙	⊙	○ (OFF)	○ (0 dB)	○	○ (OFF)	×	×	×	×	×	
neural	○	⊙	⊙	⊙	⊙	×	×	○	×	×	×	×	×	×	
5CH / 7CH STEREO	○	⊙	⊙	⊙	⊙	○ (OFF)	○ (0 dB)	○	×	×	×	×	×	×	
ROCK ARENA	○	⊙	⊙	⊙	⊙	○ (OFF)	○ (0 dB)	○	×	×	○ (medium)	○ (10)	×	×	
JAZZ CLUB	○	⊙	⊙	⊙	⊙	○ (OFF)	○ (0 dB)	○	×	×	○ (medium)	○ (10)	×	×	
MONO MOVIE	○	⊙	⊙	⊙	⊙	○ (OFF)	○ (0 dB)	○	×	×	○ (medium)	○ (10)	×	×	
VIDEO GAME	○	⊙	⊙	⊙	⊙	○ (OFF)	○ (0 dB)	○	×	×	○ (medium)	○ (10)	×	×	
MATRIX	○	⊙	⊙	⊙	⊙	○ (OFF)	○ (0 dB)	○	×	×	×	×	○ (30 ms)	×	
VIRTURL	○	×	×	×	⊙	○ (OFF)	○ (0 dB)	×	×	×	×	×	×	×	

○ : Signal / Adjustable

× : No signal / Not adjustable

⊙ : Turned on or off by speaker configuration setting

NOTE1 : This parameter is available when "Surround Parameter" – "MODE" is set to "CINEMA" (page 27).

NOTE2 : This parameter is available when "Surround Parameter" – "MODE" is set to "CINEMA" or "PL" (page 27).

NOTE:

*1 : When playing Dolby Digital and DTS signals.

*2 : When playing Dolby Digital, DTS and DVD-Audio.

Getting Started
Connections
Setup
Playback
Remote Control
Multi-Zone
Information
Troubleshooting

Surround mode	Signals and adjustability in the different modes							
	Parameter (default values are shown in parentheses)							
	PRO LOGIC II/IIx MUSIC mode only			NEO:6 MUSIC mode only	EXT. IN only	Tone Control	Night Mode	RESTORER
	PANORAMA	DIMENSION	CENTER WIDTH	CENTER IMAGE	SUBWOOFER ATT.			
DIRECT	×	×	×	×	×	×	○ (OFF)	○
STEREO	×	×	×	×	×	○ (0 dB)	○ (OFF)	○
EXT. IN	×	×	×	×	○	×	×	×
DOLBY PRO LOGIC IIx	○ (OFF)	○ (3)	○ (3)	×	×	○ (0 dB)	○ (OFF)	○
DOLBY PRO LOGIC II	○ (OFF)	○ (3)	○ (3)	×	×	○ (0 dB)	○ (OFF)	○
DTS NEO:6	×	×	×	○ (0.3)	×	○ (0 dB)	○ (OFF)	○
DOLBY DIGITAL	×	×	×	×	×	○ (0 dB)	○ (OFF)	×
DTS SURROUND	×	×	×	×	×	○ (0 dB)	○ (NOTE4)	×
neural	×	×	×	×	×	○ (0 dB)	○ (OFF)	×
5CH / 7CH STEREO	×	×	×	×	×	○ (0 dB)	○ (OFF)	○
ROCK ARENA	×	×	×	×	×	○ (NOTE3)	○ (OFF)	○
JAZZ CLUB	×	×	×	×	×	○ (0 dB)	○ (OFF)	○
MONO MOVIE	×	×	×	×	×	○ (0 dB)	○ (OFF)	○
VIDEO GAME	×	×	×	×	×	○ (0 dB)	○ (OFF)	○
MATRIX	×	×	×	×	×	○ (0 dB)	○ (OFF)	○
VIRTURL	×	×	×	×	×	○ (0 dB)	○ (OFF)	○

○ : Adjustable
 × : Not adjustable
 NOTE3 : BASS +6 dB, TREBLE +4 dB
 NOTE4 : This parameter is invalid during input of the "DTS 96/24" signal.

Differences in Surround Mode Names Depending on the Input Signals

Button	Surround mode	Note	Input signals												
			ANALOG	LINEAR PCM	DTS				DOLBY DIGITAL					DVD-AUDIO	
					DTS ES DSCRT (With Flag)	DTS ES MTRX (With Flag)	DTS (5.1ch)	DTS 96/24	DOLBY DIGITAL EX (With Flag)	DOLBY DIGITAL EX (With no Flag)	DOLBY DIGITAL (5.1/5/4ch)	DOLBY DIGITAL (4/3ch)	DOLBY DIGITAL (2ch)	DVD-Audio (multi ch)	DVD-Audio (2ch)
STANDARD															
DTS SURROUND															
	DTS ES DSCRT6.1	*1	×	×	●	×	×	×	×	×	×	×	×	×	×
	DTS ES MTRX6.1	*1	×	×	×	●	×	×	×	×	×	×	×	×	×
	DTS SURROUND		×	×	○	○	●	×	×	×	×	×	×	×	×
	DTS 96/24		×	×	×	×	×	●	×	×	×	×	×	×	×
	DTS + PLIIx CINEMA	*2	×	×	○	○	○	○	×	×	×	×	×	×	×
	DTS + PLIIx MUSIC	*1	×	×	○	○	○	○	×	×	×	×	×	×	×
	DTS + NEO:6	*1	×	×	×	○	○	○	×	×	×	×	×	×	×
	DTS NEO:6 CINEMA		○	○	×	×	×	×	×	×	×	×	○	×	○
	DTS NEO:6 MUSIC		○	○	×	×	×	×	×	×	×	×	○	×	○
DOLBY SURROUND															
	DOLBY DIGITAL EX	*1	×	×	×	×	×	×	○	○	○	○	×	×	×
	DOLBY DIGITAL		×	×	×	×	×	×	○	●	●	●	×	×	×
	DOLBY DIGITAL + PLIIx CINEMA	*2	×	×	×	×	×	×	●	○	○	○	×	×	×
	DOLBY DIGITAL + PLIIx MUSIC	*1	×	×	×	×	×	×	○	○	○	○	×	×	×
	DOLBY PRO LOGIC IIx CINEMA		○	○	×	×	×	×	×	×	×	×	●	×	○
	DOLBY PRO LOGIC IIx MUSIC		○	○	×	×	×	×	×	×	×	×	○	×	○
	DOLBY PRO LOGIC IIx GAME		○	○	×	×	×	×	×	×	×	×	○	×	○
	DOLBY PRO LOGIC II CINEMA		○	○	×	×	×	×	×	×	×	×	○	×	○
	DOLBY PRO LOGIC II MUSIC		○	○	×	×	×	×	×	×	×	×	○	×	○
	DOLBY PRO LOGIC II GAME		○	○	×	×	×	×	×	×	×	×	○	×	○
	DOLBY PRO LOGIC		○	○	×	×	×	×	×	×	×	×	○	×	○
	neural		○	○	×	×	×	×	×	×	×	×	×	×	○

NOTE:

*1: This mode is not available when the surround back speaker setup is set to "None".

*2: This mode is not available when the surround back speaker setup is set to "1spkr" or "None".

● : Mode selectable in initial status

○ : Selectable mode

×

Button	Surround mode	Note	Input signals													
			ANALOG	LINEAR PCM	DTS				DOLBY DIGITAL					DVD-AUDIO		
					DTS ES DSCRT (With Flag)	DTS ES MTRX (With Flag)	DTS (5.1ch)	DTS 96/24	DOLBY DIGITAL EX (With Flag)	DOLBY DIGITAL EX (With no Flag)	DOLBY DIGITAL (5.1/5/4ch)	DOLBY DIGITAL (4/3ch)	DOLBY DIGITAL (2ch)	DVD-Audio (multi ch)	DVD-Audio (2ch)	
DIRECT																
	DIRECT		○	○	○	○	○	○	○	○	○	○	○	○	×	○
DSP SIMULATION																
	5CH / 7CH STEREO	*3	○	○	○	○	○	○	○	○	○	○	○	○	×	○
	ROCK ARENA		○	○	○	○	○	○	○	○	○	○	○	○	×	○
	JAZZ CLUB		○	○	○	○	○	○	○	○	○	○	○	○	×	○
	MONO MOVIE		○	○	○	○	○	○	○	○	○	○	○	○	×	○
	VIDEO GAME		○	○	○	○	○	○	○	○	○	○	○	○	×	○
	MATRIX		○	○	○	○	○	○	○	○	○	○	○	○	×	○
	VIRTUAL		○	○	○	○	○	○	○	○	○	○	○	○	×	○
STEREO																
	STEREO		●	●	○	○	○	○	○	○	○	○	○	○	×	●

NOTE :

*3: If the surround back speaker setup is set to "None", then "5CH STEREO" is displayed.

● : Mode selectable in initial status

○ : Selectable mode

× : Non-selectable mode

Troubleshooting

If a problem should arise, first check the following:

1. Are the connections correct?
2. Is the set being operated as described in the owner's manual?
3. Are the other components operating properly?

If this unit does not operate properly, check the items listed in the table below. Should the problem persist, there may be a malfunction.

In this case, disconnect the power immediately and contact your store of purchase.

[General]

Symptom	Cause	Countermeasure	Page
Power does not turn on, or turns off directly after it was turned on.	<ul style="list-style-type: none"> • Connection of the power cord is faulty. 	<ul style="list-style-type: none"> • Check the insertion of the power supply cord plug. 	17
No sound is produced from speakers.	<ul style="list-style-type: none"> • Connection with the input devices or connection of the speaker cables is faulty. 	<ul style="list-style-type: none"> • Check the connections. 	9 ~ 17
	<ul style="list-style-type: none"> • Device you want to play and set input source do not match. 	<ul style="list-style-type: none"> • Select an appropriate input source. 	31
	<ul style="list-style-type: none"> • Master volume is turned too low. 	<ul style="list-style-type: none"> • Adjust the master volume to an appropriate level. 	31
	<ul style="list-style-type: none"> • Mute mode is set. • Headphones are connected. 	<ul style="list-style-type: none"> • Cancel the mute mode. • Disconnect the headphones. 	32 32
	<ul style="list-style-type: none"> • No digital signals are being input. 	<ul style="list-style-type: none"> • Select an input source for which the digital input setting has been made. 	22
	<ul style="list-style-type: none"> • The connectors to which the digital inputs are assigned and the settable input modes do not match. 	<ul style="list-style-type: none"> • Set the input mode. 	31
Display is off.	<ul style="list-style-type: none"> • The dimmer setting is set to "OFF". 	<ul style="list-style-type: none"> • Set to something other than "OFF". 	32
"DOLBY DIGITAL" indicator does not appear on display.	<ul style="list-style-type: none"> • DVD player's digital audio output setting is not proper. 	<ul style="list-style-type: none"> • Check the DVD player's audio output setting. For details, read the DVD player's operating instructions. 	-

Symptom	Cause	Countermeasure	Page
Power turns off suddenly and power indicator flashes red.	<ul style="list-style-type: none"> • Protection circuit activated due to rise of internal temperature. 	<ul style="list-style-type: none"> • Turn off the power, wait for the set to fully cool down, then turn the power back on. 	9
	<ul style="list-style-type: none"> • Core wires of two speakers are touching each other or a core wire is sticking out of the terminal and touching the set's rear panel, activating the protection circuit. 	<ul style="list-style-type: none"> • Place the set in a well-ventilated place. • First unplug the power cord, then twist the core wires tightly or terminate the speaker cables, then reconnect. 	9
	<ul style="list-style-type: none"> • Speakers with an impedance other than specified are being used. 	<ul style="list-style-type: none"> • Use speakers with the specified impedance. 	9
	<ul style="list-style-type: none"> • Set is damaged. 	<ul style="list-style-type: none"> • Turn off the power and contact a DENON service center. 	-

[Remote Control Unit]

Symptom	Cause	Countermeasure	Page
Set does not work properly when remote control unit operated.	<ul style="list-style-type: none"> • Batteries are worn. 	<ul style="list-style-type: none"> • Replace with new batteries. 	3
	<ul style="list-style-type: none"> • You are operating outside of the specified range. 	<ul style="list-style-type: none"> • Operate within the specified range. 	3
	<ul style="list-style-type: none"> • Obstacle between main unit and remote control unit. 	<ul style="list-style-type: none"> • Remove the obstacle. 	3
	<ul style="list-style-type: none"> • The batteries are not inserted in the proper direction, as indicated by the polarity marks in the battery compartment. 	<ul style="list-style-type: none"> • Insert the batteries in the proper direction, following the polarity marks in the battery compartment. 	3
	<ul style="list-style-type: none"> • The set's remote control sensor is exposed to strong light (direct sunlight, inverter type fluorescent bulb light, etc.). 	<ul style="list-style-type: none"> • Move the set to a place in which the remote control sensor will not be exposed to strong light. 	3
	<ul style="list-style-type: none"> • The remote ID of the main unit and remote control unit do not match. 	<ul style="list-style-type: none"> • Set "Remote ID" for the main unit to "1". 	25

[Audio]

Symptom	Cause	Countermeasure	Page
No sound is produced from center speaker.	<ul style="list-style-type: none"> You are playing a monaural source (TV, AM radio broadcast, etc.) in the "STANDARD" (Dolby/DTS Surround) mode. 	<ul style="list-style-type: none"> The mode is set to something other than "STANDARD" (Dolby/DTS Surround). 	26
No sound is produced from surround speakers.	<ul style="list-style-type: none"> The surround mode is set to "STEREO" or "DIRECT". 	<ul style="list-style-type: none"> Set to a surround playback mode. 	26
No sound is produced from surround back speaker.	<ul style="list-style-type: none"> The surround back speaker's power amplifier is assigned to a different channel. Surround back speaker setting is set to "None". Surround mode not set to a mode for 6.1- or 7.1-channel playback. 	<ul style="list-style-type: none"> Check the setting and change it as necessary. Set to something other than "None". Select a surround playback mode. 	24 20 25, 26
No sound is produced from subwoofer.	<ul style="list-style-type: none"> Subwoofer's power not turned on. The "Subwoofer" setting at "Speaker Setup" is set to "No". The subwoofer is not properly connected. The subwoofer's volume is turned off. 	<ul style="list-style-type: none"> Turn on the subwoofer's power. Set to "Yes". Check the connections. Adjust the subwoofer's volume to an appropriate level. 	- 20 9 37
No test tones are produced when remote control unit's TEST button is pressed.	<ul style="list-style-type: none"> Surround mode not set to "STANDARD" (Dolby/DTS Surround). 	<ul style="list-style-type: none"> Set to the "STANDARD" (Dolby/DTS Surround) mode. 	26
DTS sound is not output.	<ul style="list-style-type: none"> DVD player's audio output setting is not set to bitstream. DVD player is not compatible with DTS sound playback. The AVR-588's "Input Mode" setting is set to other than "DTS". 	<ul style="list-style-type: none"> Set the DVD player. For details, refer to the DVD player's operating instructions. Use a DTS-compatible player. Set to the "Auto" or "DTS" mode. 	- - 31
HDMI audio signals are not output from speakers.	-	<ul style="list-style-type: none"> The audio signal input to the HDMI input connector cannot be played on the AVR-588. Input the audio signal to the digital audio input connector or analog audio input connector. 	10
No sound is output from the monitor connected with HDMI connections.	<ul style="list-style-type: none"> HDMI input setting is improper. 	<ul style="list-style-type: none"> Check the HDMI input setting. 	22

[Video]

Symptom	Cause	Countermeasure	Page
No picture appears.	<ul style="list-style-type: none"> The connections between the AVR-588 and monitor are faulty. The monitor's input setting is wrong. The player is connected using the component input connectors, the monitor is connected using the video (yellow) or S-Video output connectors. 	<ul style="list-style-type: none"> Check the connections. Set properly. High definition (1080i/720p) and progressive (480p/576p) video signals are not down-converted. Set the player to interlace (480i/576i) signals. 	10 ~ 17 - -
No picture appears with HDMI connections.	<ul style="list-style-type: none"> The connections to the HDMI connectors are faulty. HDMI input setting is improper. The HDMI format of the player and monitor do not match. 	<ul style="list-style-type: none"> Check the connections. Check the HDMI input setting. Match the HDMI format of the player and monitor. 	10 22 10
DVDs cannot be copied on a VCR.	-	<ul style="list-style-type: none"> This is not a malfunction. Most movie software includes copy prevention signals and cannot be copied. 	-

[iPod]

Symptom	Cause	Countermeasure	Page
iPod cannot be played.	<ul style="list-style-type: none"> The input source assigned to Control Dock for iPod is not selected. Cable is not properly connected. Control Dock for iPod's AC adapter is not connected to power outlet. 	<ul style="list-style-type: none"> Switch to the input source assigned at Control Dock for iPod. Reconnect. Plug the Control Dock for iPod's AC adapter into a power outlet. 	23
			12
			–

[XM Satellite Radio]

Symptom	Cause	Countermeasure	Page
"CHECK ANTENNA" is displayed in the XM mode.	<ul style="list-style-type: none"> AVR-588's XM connector and the XM Mini-Tuner and Home Dock is not properly connected. 	<ul style="list-style-type: none"> Check that the connections are correct. 	15
"NO SIGNAL" is displayed in the XM mode.	<ul style="list-style-type: none"> The signal cannot be received. 	<ul style="list-style-type: none"> Reposition your XM Mini-Tuner and Home Dock antenna. 	34
"OFF AIR" is displayed in the XM mode.	<ul style="list-style-type: none"> The selected channel is not currently broadcasting. 	<ul style="list-style-type: none"> Select another channel. 	34, 35
Receiving only XM channels 0 and 1.	<ul style="list-style-type: none"> The XM Tuner is not activated. 	<ul style="list-style-type: none"> Contact XM Radio. 	34

Specifications

Audio section

Power amplifier

Rated output:

Front (A, B):
 75 W + 75 W (8 Ω/ohms, 20 Hz ~ 20 kHz with 0.08 % T.H.D.)
 110 W + 110 W (6 Ω/ohms, 1 kHz with 0.7 % T.H.D.)

Center:

75 W (8 Ω/ohms, 20 Hz ~ 20 kHz with 0.08 % T.H.D.)
 110 W (6 Ω/ohms, 1 kHz with 0.7 % T.H.D.)

Surround:

75 W + 75 W (8 Ω/ohms, 20 Hz ~ 20 kHz with 0.08 % T.H.D.)
 110 W + 110 W (6 Ω/ohms, 1 kHz with 0.7 % T.H.D.)

Surround Back:

75 W + 75 W (8 Ω/ohms, 20 Hz ~ 20 kHz with 0.08 % T.H.D.)
 110 W + 110 W (6 Ω/ohms, 1 kHz with 0.7 % T.H.D.)

Output connectors:

Front: A or B 6 ~ 16 Ω/ohms
 A + B 12 ~ 16 Ω/ohms
 Center, Surround, Surround Back: 6 ~ 16 Ω/ohms

Analog

Input sensitivity / Input impedance:

200 mV / 47 kΩ/kohms

Frequency response:

10 Hz ~ 100 kHz — +1, -3 dB (DIRECT mode)

S/N:

98 dB (IHF-A weighted, DIRECT mode)

Video section

Standard video connectors

Input / output level and impedance:

1 Vp-p, 75 Ω/ohms

Frequency response:

5 Hz ~ 10 MHz — +1, -3 dB

S-Video connectors

Input / output level and impedance:

Y (brightness) signal — 1 Vp-p, 75 Ω/ohms
 C (color) signal — 0.286 Vp-p, 75 Ω/ohms

Frequency response:

5 Hz ~ 10 MHz — +1, -3 dB

Color component video connectors

Input / output level and impedance:

Y (brightness) signal — 1 Vp-p, 75 Ω/ohms
 P_B / C_B signal — 0.7 Vp-p, 75 Ω/ohms
 P_R / C_R signal — 0.7 Vp-p, 75 Ω/ohms

Frequency response:

5 Hz ~ 30 MHz — +0, -3 dB

Tuner section

Receiving Range:

[FM]
 (note: μV at 75 Ω/ohms, 0 dBf = 1 × 10⁻¹⁵ W)
 87.5 MHz ~ 107.9 MHz

Usable Sensitivity:

1.0 μV (11.2 dBf)

50 dB Quieting Sensitivity:

MONO 1.6 μV (15.3 dBf)

STEREO 23 μV (38.5 dBf)

S/N (IHF-A):

MONO 77 dB

STEREO 72 dB

Total harmonic Distortion (at 1 kHz):

MONO 0.15 %

STEREO 0.3 %

[AM]

520 kHz ~ 1710 kHz

18 μV

General

Power supply:

AC 120 V, 60 Hz

Power consumption:

4.3 A

0.3 W (Standby)

Maximum external dimensions:

434 (W) × 171 (H) × 377 (D) mm (17-3/32" × 6-47/64" × 14-27/32")

Weight:

10.9 kg (24 lbs 0.5 oz)

Remote control unit (RC-1075)

Batteries:

R6P/AA Type (two batteries)

Maximum external dimensions:

52 (W) × 243 (H) × 21 (D) mm (2-3/64" × 9-9/16" × 53/64")

Weight:

184 g (Approx. 6.5 oz) (including batteries)

* For purposes of improvement, specifications and design are subject to change without notice.

List of preset codes / Liste de codes pré-régulés

DVD Player

A	Aiwa	009
D	Denon	014, [111]*
H	Hitachi	010
J	JVC	006, 011
K	Konka	012, 013
M	Magnavox	005
	Mitsubishi	004
P	Panasonic	014
	Philips	005, 015, 016, 017
	Pioneer	003, 008
S	Sanyo	018
	Sony	002, 019, 020
T	Toshiba	001, 021, 022
Z	Zenith	023

VDP

D	Denon	028, 029, 112
M	Magnavox	026
	Mitsubishi	028
P	Panasonic	029, 030
	Philips	026
	Pioneer	028, 031
R	RCA	032
S	Sony	033, 034, 035, 036

VCR

A	Admiral	081
	Aiko	095
	Aiwa	009
	Akai	026, 027, 070, 072, 082, 083, 084
	Alba	055
	Amstrad	009
	ASA	042
	Asha	087
	Audio Dynamic	005, 085
	Audiovox	088
	Beaumarck	087
	Broksonic	086, 093
C	Calix	088
	Candle	006, 087, 088, 089, 090
	Canon	049, 057
	Capehart	025, 055, 056, 071
	Carver	015
	CCE	095
	Citizen	006, 007, 087, 088, 089, 090, 095
	Craig	007, 087, 088, 091, 115

	Curtis Mathes	006, 049, 073, 080, 087, 090, 092
	Cybernex	087
D	Daewoo	025, 055, 059, 074, 089, 093, 095, 096
	Daytron	025, 055
	DBX	005, 085
	Dumont	053
	Dynatech	009
E	Electrohome	001, 088, 097
	Electroponic	088
	Emerson	001, 009, 017, 027, 086, 088, 089, 092, 093, 097, 100, 101, 102, 103, 104, 117
F	Fisher	009, 028, 031, 053, 054, 091, 099, 115
G	GE	007, 011, 049, 050, 051, 052, 073, 080, 087
	Go Video	047, 048
	Goldstar	000, 006, 012, 062, 088
	Gradiente	094
	Grundig	042
H	Harley Davidson	094
	Harman Kardon	040, 062
	Hi-Q	091
	Hitachi	009, 013, 023, 026, 058, [108]*, 109, 110, 111
J	JC Penny	004, 005, 007, 023, 028, 049, 062, 085, 087, 088
	Jensen	013, 026
	JVC	004, 005, 006, 026, 029, 043, 044, 045, 046, 085
K	Kenwood	004, 005, 006, 026, 029, 033, 045, 085, 090
	Kodak	088
L	Lloyd	009, 094
	LXI	088
M	Magnavox	015, 016, 042, 049, 063, 106
	Magnin	087
	Marantz	004, 005, 006, 015, 042, 049, 085, 090
	Marta	088
	MEI	049
	Memorex	009, 033, 049, 053, 060, 081, 087, 088, 091, 094, 115
	Metz	123, 124, 125, 126, 127, 128
	MGA	001, 017, 027, 041, 097
	MGN Technology	087
	Midland	011
	Minolta	013, 023
	Mitsubishi	001, 003, 008, 013, 014, 017, 027, 029, 039, 040, 041, 045, 097
	Motorola	081
	Montgomery Ward	001, 002, 007, 009, 049, 063, 081, 115, 117
	MTC	009, 087, 094

	Multitech	007, 009, 011, 087, 090, 094
N	NAD	038
	NEC	004, 005, 006, 018, 026, 029, 045, 061, 062, 085
	Nikko	088
	Noblex	087
O	Optimus	081, 088
	Optonica	021
P	Panasonic	024, 049, 064, 066, 067, 068, 069, 107
	Perdio	009
	Pentax	009, 013, 023, 058, 090
	Philco	015, 016, 049
	Philips	015, 021, 042, 049, 105
	Pilot	088
	Pioneer	005, 013, 029, 036, 037, 038, 045, 085
	Portland	025, 055, 090
	Proscan	063, 080
	Pulsar	060
Q	Quartz	033
	Quasar	034, 035, 049
R	Radio Shack	001, 002, 021, 081, 087, 088, 091, 094, 097, 098, 115
	Radix	088
	Randex	088
	RCA	007, 013, 019, 023, 058, 063, 064, 065, 073, 080, 082, 087, 089, 021, 031, 033, 049, 053, 081, 087, 088, 091, 094, 097, 098
	Realistic	009, 021, 031, 033, 049, 053, 081, 087, 088, 091, 094, 097, 098
	Ricoh	055
S	Salora	033, 041
	Samsung	007, 011, 051, 059, 070, 083, 087, 089, 113
	Sanky	081
	Sansui	005, 026, 029, 045, 061, 085, 114
	Sanyo	032, 033, 053, 087, 091, 115, 116
	SBR	042
	Scott	017, 020, 086, 089, 093, 117
	Sears	013, 023, 028, 031, 033, 053, 054, 088, 091, 098, 099, 115
	Sentra	055
	Sharp	001, 002, 021, 097
	Shogun	087
	Sony	075, 076, 077, 078, 079, 121, 122
	STS	023
	Sylvania	009, 015, 016, 017, 041, 049, 094
	Symphonic	009, 094
T	Tandy	009
	Tashiko	009, 088
	Tatung	004, 026, 030

	Teac	004, 009, 026, 094
	Technics	024, 049
	TMK	087, 092
	Toshiba	013, 017, 020, 041, 059, 089, 098, 099, 117
	Totevision	007, 087, 088
U	Unirech	087
V	Vectror Research	005, 062, 085, 089, 090
	Victor	005, 045, 046, 085
	Video Concepts	005, 027, 085, 089, 090
	Videosonic	007, 087
W	Wards	013, 021, 023, 087, 088, 089, 091, 094, 097, 118, 119, 120
X	XR-1000	094
Y	Yamaha	004, 005, 006, 026, 062, 085
Z	Zenith	060, 078, 079

Television

A	Admiral	045, 121
	Adventura	122
	Aiko	054
	Akai	016, 027, 046
	Alleron	062
	A-Mark	007
	Amtron	061
	Anam	006, 007, 036
	Anam National	061, 147
	AOC	003, 007, 033, 038, 039, 047, 048, 049, 133
	Archer	007
	Audiovox	007, 061
B	Bauer	155
	Belcor	047
	Bell & Howell	045, 118
	Bradford	061
	Brockwood	003, 047
C	Candle	003, 030, 031, 032, 038, 047, 049, 050, 122
	Capehart	003
	Celebrity	046
	Circuit City	003
	Citizen	029, 030, 031, 032, 034, 038, 047, 049, 050, 054, 061, 095, 122, 123
	Concerto	031, 047, 049
	Colortyme	003, 047, 049, 135
	Contec	013, 051, 052, 061
	Cony	051, 052, 061
	Craig	004, 061
	Crown	029
	Curtis Mathes	029, 034, 038, 044, 047, 049, 053, 095, 118

D	Daewoo	027, 029, 039, 048, 049, 054, 055, 106, 107, 137
	Daytron	003, 049
	Dimensia	044
	Dixi	007, 015, 027
E	Electroband	046
	Electrohome	029, 056, 057, 058, 147
	Elta	027
	Emerson	029, 051, 059, 060, 061, 062, 118, 123, 124, 139, 148
	Envision	038
	Etron	027
F	Fisher	014, 021, 063, 064, 065, 118
	Formenti	155
	Fortress	012
	Fujitsu	004, 062
	Funai	004, 062
	Futuretech	004
G	GE	020, 036, 037, 040, 044, 058, 066, 088, 119, 120, 125, 147
	Goldstar	000, 015, 029, 031, 039, 048, 051, 056, 057, 067, 068, 069, 116
	Grundy	062
H	Hitachi	029, 031, 051, 052, 070, 111, 112, 113, 124, [134]*
	Hitachi Pay TV	151
I	Infinity	017, 071
J	Janeil	122
	JBL	017, 071
	JC Penny	020, 034, 039, 040, 041, 044, 048, 050, 058, 066, 069, 076, 088, 090, 095, 125, 136, 159
	JCB	046
	JVC	019, 051, 052, 072, 073, 091, 117, 126
K	Kawasho	018, 046
	Kenwood	038, 056, 057
	Kloss	010, 032
	Kloss Novabeam	005, 122, 127, 131
	KTV	074, 123
L	Loewe	071
	logik	144
	Luxman	031
	LXI	008, 014, 017, 024, 040, 044, 063, 071, 075, 076, 077, 118, 125
M	Magnavox	005, 010, 017, 030, 033, 038, 050, 056, 071, 078, 079, 085, 089, 108, 109, 110, 127, 131, 132, 145
	Marantz	015, 017, 071, 080
	Matsui	027
	Memorex	014, 027, 045, 083, 118, 144
	Metz	160, 161, 162, 163

MGA	001, 039, 048, 056, 057, 058, 065, 081, 083
Midland	125
Minutz	066
Mitsubishi	001, 016, 039, 048, 056, 057, 058, 065, 081, 082, 083, 105
Montgomery Ward	011, 020, 144, 145, 146
Motorola	121, 147
MTC	031, 034, 039, 048, 095
N	
NAD	008, 075, 076, 128
National	002, 036, 061, 147
National Quenties	002
NEC	031, 038, 039, 048, 057, 084, 086, 135, 147
Nikko	054
NTC	054
O	
Optimus	128
Optonica	011, 012, 093, 121
Orion	004, 139
P	
Panasonic	002, 009, 017, 036, 037, 071, 141, 143, 147
Philco	005, 010, 030, 050, 051, 056, 079, 085, 127, 131, 132, 145, 147
Philips	005, 015, 017, 050, 051, 056, 078, 087, 088, 089, 131, 132, 147
Pioneer	124, 128, 142
Portland	054
Price Club	095
Proscan	040, 044, 125
Proton	035, 051, 092, 129
Pulsar	042
Q	
Quasar	036, 037, 074, 141
R	
Radio Shack	011, 044, 063, 093, 118
RCA	040, 044, 125, 130, 137, 151, 152
Realistic	014, 063, 093, 118
S	
Saisho	027
Samsung	003, 015, 034, 053, 055, 057, 094, 095, 136, 153
Sansui	139
Sanyo	013, 014, 021, 022, 063, 064, 081, 096
SBR	015
Schneider	015
Scott	062
Sears	008, 014, 021, 022, 023, 024, 025, 040, 052, 057, 062, 063, 064, 065, 073, 075, 076, 097, 098, 125, 159
Sharp	011, 012, 013, 026, 093, 099, 100, 104, 121
Siemens	013
Signature	045, 144
Simpson	050
Sony	043, 046, 138, 146, 150
Soundesign	030, 050, 062
Spectricon	007, 033

Squareview	004
Supre-Macy	032, 122
Supreme	046
Sylvania	005, 010, 017, 030, 078, 079, 085, 089, 101, 127, 131, 132, 145, 155
Symphonic	004, 148
T	
Tandy	012, 121
Tatung	036, 124
Technics	037
Teknika	001, 030, 032, 034, 052, 054, 078, 083, 095, 144, 156, 157
Tera	035, 129
THOMSON	165, 166
Toshiba	008, 014, 034, 063, 075, 076, 095, 097, 136, 158, 159
U	
Universal	020, 066, 088
V	
Victor	019, 073, 126
Video Concepts	016
Viking	032, 122
W	
Wards	005, 045, 066, 078, 085, 088, 089, 093, 102, 103, 131, 132, 148
Z	
Zenith	042, 114, 115, 140, 144, 149
Zonda	007

Cable

A	ABC	006, [007]*, 008, 009
	Archer	010, 011
C	Century	011
	Citizen	011
	Colour Voice	012, 013
	Comtronic	014
E	Eastern	015
G	Garrard	011
	Gemini	030, 033, 034
	General Instrument	030, 031, 032
H	Hytex	006
J	Jasco	011
	Jerrold	009, 016, 017, 026, 032
M	Magnavox	018
	Movie Time	019
N	NSC	019
O	Oak	000, 006, 020
P	Panasonic	001, 005
	Philips	011, 012, 013, 018, 021
	Pioneer	002, 003, 022
R	RCA	029
	Regency	015
S	Samsung	014, 023
	Scientific Atlanta	004, 024, 025
	Signal	014
	SL Marx	014
	Starcom	009

Stargate	014
T	
Televue	014
Tocom	007, 016
TV86	019
U	
Unika	011
United Artists	006
Universal	010, 011
V	
Viewstar	018, 019
Z	
Zenith	027, 028

Satellite Receiver

A	Alphastar	054
C	Chaparrali	035, 036
D	Dishnet	053
	Drake	037, 038
E	Echostar Dish	062, 066
G	GE	048, 055, 056
	General Instruments	039, 040, 041
	Grundig	070, 071, 072, 073
H	Hitachi	058, 059
	Hughes Networkr	063, 064, 065, 069
J	JVC	057
K	Kathrein	074, 075, 076, 083
M	Magnavoxl	060
N	Nokia	070, 080, 084, 085, 086
P	Philips	060
	Primestar	051
	Proscan	048, 055, 056
R	RCA	048, 055, 056, 068
	Realistic	042
S	Sierra I	036
	Sierra II	036
	Sierra III	036
	Sony	049, 067
	STS1	043
	STS2	044
	STS3	045
	SRS4	046
T	Technisat	077, 078, 079, 081, 082
	Toshiba	047, 050
	Uniden	061

CD Player

A	Aiwa	001, 035, 043
B	Burmster	002
C	Carvery	003, 035
D	Denon	[111]*, 044
E	Emerson	004, 005, 006, 007
F	Fisher	003, 008, 009, 010
J	JVC	018, 019

Kenwood	011, 012, 013, 014, 017
M	
Magnavox	006, 015, 035
Marantz	016, 028, 035
MCS	016, 024
O	
Onkyo	025, 027
Optimus	017, 020, 021, 022, 023
P	
Philips	014, 032, 033, 035
Pioneer	006, 022, 030
S	
Sears	006
Sony	023, 031
T	
Teac	002, 009, 028
Technics	016, 029, 036
W	
Wards	035, 037
Y	
Yamaha	038, 039, 040, 041
Z	
Zenith	042

CD Recorder

D	Denon	[151]*, 112
P	philips	112

MD Recorder

A	Kenwood	053, 054
B	Onkyo	057
C	Sharp	055
D	Denon	113
E	Sony	056

Tape Deck

A	Aiwa	001, 002
C	Carver	002
D	Denon	111
H	Harman/Kardon	002, 003
J	JVC	004, 005
K	Kenwood	006
M	Magnavox	002
	Marantz	002
O	Onkyo	016, 018
	Optimus	007, 008
P	Panasonic	012
	Philips	002
	pioneer	007, 008, 009
S	Sony	013, 014, 015
T	Technics	012
V	Victor	004
W	Wards	007
Y	Yamaha	010, 011

DVD preset codes / Codes pré-régés DVD		
DENON Model No. / Modèle numéro	111 (default / défaut)	014
	DVD-555	DVD-2910
DVD-755	DVD-2930CI	DVD-1600
DVD-900	DVD-3800	DVD-2000
DVD-910	DVD-3910	DVD-2500
DVD-955	DVD-3930CI	DVD-3000
DVD-1000	DVD-5900	DVD-3300
DVD-1200	DVD-5910	
DVD-1500	DVD-9000	
DVD-1710	DVM-715	
DVD-1910	DVM-1800	
DVD-1930CI	DVM-1805	
DVD-2200	DVM-1815	
DVD-2800	DVM-2815	
DVD-2800II	DVM-4800	
DVD-2900		

[]* : Preset codes set upon shipment from the factory.
 : Les codes pré-régés diffèrent en fonction des livraisons de l'usine.





DENON

www.denon.com

Denon Brand Company, D&M Holdings Inc.
Printed in China 00D 511 4640 102